

MELSEC-ST Analog-Digital
Converter Module

User's Manual

MITSUBISHI

(CC-Link)

MELSEC-ST
MELSEC-ST

MELSEC-ST

ST1AD2-V
ST1AD2-I

● SAFETY PRECAUTIONS ●

(Read these precautions before using.)

When using Mitsubishi equipment, thoroughly read this manual and the associated manuals introduced in this manual. Also pay careful attention to safety and handle the module properly.

The precautions given in this manual are concerned with this product only. Refer to the user's manual of the network system to use for a description of the network system safety precautions.

These SAFETY PRECAUTIONS classify the safety precautions into two categories: "DANGER" and "CAUTION".



DANGER

Indicates that incorrect handling may cause hazardous conditions, resulting in death or severe injury.



CAUTION

Indicates that incorrect handling may cause hazardous conditions, resulting in medium or slight personal injury or physical damage.

Depending on circumstances, procedures indicated by  CAUTION may also be linked to serious results. In any case, it is important to follow the directions for usage.

Store this manual in a safe place so that you can take it out and read it whenever necessary. Always forward it to the end user.

[DESIGN PRECAUTIONS]

DANGER

- Create an interlock circuit on the program so that the system will operate safely based on the communication status information. Failure to do so may cause an accident due to an erroneous output or malfunction.

When an error occurs, all outputs are turned off in the MELSEC-ST system. (At default)

However, I/O operations of the head module and respective slice modules can be selected for the following errors:

(1) Communication error (☞ MELSEC-ST CC-Link Head Module User's Manual "4.3.1 Output status setting for module error")

(2) Slice module error

The output status for the case of an error can be set to Clear, Hold, or Preset with a command parameter of each slice module. (For the setting availability, refer to each slice module manual.)

Since the parameter is set to Clear by default, outputs will be turned off when an error occurs.

This parameter setting can be changed to Hold or Preset when the system safety is more ensured by holding or presetting the output.

[DESIGN PRECAUTIONS]

DANGER

- Create an external failsafe circuit so that the MELSEC-ST system will operate safely, even when the external power supply or the system fails.
Failure to do so may cause an accident due to an erroneous output or malfunction.
 - (1) The status of output changes depending on the setting of various functions that control the output. Take sufficient caution when setting those functions.
 - (2) Outputs may be kept ON or OFF due to malfunctions of output elements or the internal circuits.
For signals that may cause a serious accident, configure an external monitoring circuit.

[DESIGN PRECAUTIONS]

CAUTION

- Make sure to initialize the network system after changing parameters of the MELSEC-ST system or the network system. If unchanged data remain in the network system, this may cause malfunctions.
- Do not install the control wires or communication cables together with the main circuit or power wires. Keep a distance of 100 mm (3.94 inch) or more between them. Not doing so could result in malfunctions due to noise.

[INSTALLATION PRECAUTIONS]

CAUTION

- Use the MELSEC-ST system in the general environment specified in the MELSEC-ST system users manual. Using this MELSEC-ST system in an environment outside the range of the general specifications could result in electric shock, fire, erroneous operation, and damage to or deterioration of the product.
- Mount the head module and base module on the DIN rail securely (one rail for one module) referring to the MELSEC-ST System User's Manual and then fix them with stoppers. Incorrect mounting may result in a fall of the module, short circuits or malfunctions.
- Secure the module with several stoppers when using it in an environment of frequent vibration. Tighten the screws of the stoppers within the specified torque range. Undertightening can cause a drop, short circuit or malfunction. Overtightening can cause a drop, short circuit or malfunction due to damage to the screw or module.
- Make sure to externally shut off all phases of the power supply for the whole system before mounting or removing a module. Failure to do so may damage the module.
 - (1) Online replacement of the power distribution module and/or the base module is not available.
When replacing either of the modules, shut off all phases of the external power supply.
Failure to do so may result in damage to all devices of the MELSEC-ST system.
 - (2) I/O modules and intelligent function modules can be replaced online.
Since online replacement procedures differ depending on the module type, be sure to make replacement as instructed.
For details, refer to the chapter of online module change in this manual.

[INSTALLATION PRECAUTIONS]

CAUTION

- Do not directly touch the module's conductive parts or electronic components. Doing so may cause malfunctions or failure of the module.
- Make sure to securely connect each cable connector. Failure to do so may cause malfunctions due to poor contact.
- DIN rail must be conductive; make sure to ground it prior to use. Failure to do so may cause electric shocks or malfunctions. Undertightening can cause a drop, short circuit or malfunction. Overtightening can cause a drop, short circuit or malfunction due to damage to the screw or module.

[WIRING PRECAUTIONS]

DANGER

- Completely turn off the external power supply when installing or placing wiring. Not completely turning off all power could result in electric shock or damage to the product.

CAUTION

- Make sure to ground the control panel where the MELSEC-ST system is installed in the manner specified for the MELSEC-ST system. Failure to do so may cause electric shocks or malfunctions.
- Check the rated voltage and the terminal layout and wire the system correctly. Connecting an inappropriate power supply or incorrect wiring could result in fire or damage.
- Tighten the terminal screws within the specified torque. If the terminal screws are loose, it could result in short circuits, fire, or erroneous operation. Overtightening may cause damages to the screws and/or the module, resulting in short circuits or malfunction.
- Prevent foreign matter such as chips or wiring debris from entering the module. Failure to do so may cause fires, damage, or erroneous operation.
- When connecting the communication and power supply cables to the module, always run them in conduits or clamp them. Not doing so can damage the module and cables by pulling a dangling cable accidentally or can cause a malfunction due to a cable connection fault.
- When disconnecting the communication and power supply cables from the module, do not hold and pull the cable part. Pulling the cables connected to the module can damage the module and cables or can cause a malfunction due to a cable connection fault.

[STARTUP AND MAINTENANCE PRECAUTIONS]

DANGER

- Do not touch the terminals while power is on.
Doing so could cause shock or erroneous operation.
- Make sure to shut off all phases of the external power supply for the system before cleaning the module or tightening screws.
Not doing so can cause the module to fail or malfunction.

[STARTUP AND MAINTENANCE PRECAUTIONS]

CAUTION

- Do not disassemble or modify the modules.
Doing so could cause failure, erroneous operation, injury, or fire.
- Do not drop or give a strong impact to the module since its case is made of resin. Doing so can damage the module.
- Make sure to shut off all phases of the external power supply for the system before mounting/removing the module onto/from the control panel. Not doing so can cause the module to fail or malfunction.
- Before handling the module, touch a grounded metal object to discharge the static electricity from the human body.
Failure to do so may cause a failure or malfunctions of the module.
- When using any radio communication device such as a cellular phone, keep a distance of at least 25cm (9.85 inch) away from the MELSEC-ST system.
Not doing so can cause a malfunction.

[DISPOSAL PRECAUTIONS]

CAUTION

- When disposing of this product, treat it as industrial waste.

REVISIONS

* The manual number is given on the bottom left of the back cover.

Print Date	*Manual Number	Revision
May, 2008	SH(NA)-080755ENG-A	First edition

Japanese Manual Version SH-080749-A

This manual confers no industrial property rights or any rights of any other kind, nor does it confer any patent licenses. Mitsubishi Electric Corporation cannot be held responsible for any problems involving industrial property rights which may occur as a result of using the contents noted in this manual.

INTRODUCTION

Thank you for choosing the ST1AD2-V/ST1AD2-I MELSEC-ST analog-digital converter module.
Before using the module, please read this manual carefully to fully understand the functions and performance of the ST1AD2-V/ST1AD2-I MELSEC-ST analog-digital converter module and use it correctly.

CONTENTS

SAFETY PRECAUTIONS	A - 1
REVISIONS	A - 5
INTRODUCTION	A - 6
CONTENTS	A - 6
About Manuals	A - 10
Compliance with the EMC and Low Voltage Directives	A - 10
How to Read Manual	A - 11
Generic Terms and Abbreviations	A - 13
Term definition	A - 14
Packing list	A - 15

CHAPTER1 OVERVIEW **1 - 1 to 1 - 2**

1.1 Features	1 - 1
--------------	-------

CHAPTER2 SYSTEM CONFIGURATION **2 - 1 to 2 - 3**

2.1 Overall Configuration	2 - 1
2.2 Applicable System	2 - 2
2.2.1 Applicable head module	2 - 2
2.2.2 Applicable base module	2 - 2
2.2.3 Applicable coding element	2 - 2
2.2.4 Applicable software package	2 - 2
2.3 Precautions for System Configuration	2 - 3
2.4 Checking Hardware and Software Versions	2 - 3

CHAPTER3 SPECIFICATIONS **3 - 1 to 3 - 21**

3.1 Performance Specifications	3 - 1
3.2 I/O Conversion Characteristics	3 - 2
3.2.1 Input characteristics of ST1AD2-V	3 - 2
3.2.2 Input characteristics of ST1AD2-I	3 - 4
3.2.3 Relation between the offset/gain setting and digital output value	3 - 5
3.2.4 Accuracy	3 - 6
3.2.5 Conversion speed	3 - 7
3.2.6 Intelligent function module processing time	3 - 7
3.3 Functions	3 - 8
3.3.1 Function list	3 - 8
3.3.2 A/D conversion method	3 - 10

3.3.3	Alarm output function	3 - 12
3.3.4	Disconnection detection function	3 - 14
3.4	I/O Data	3 - 16
3.4.1	Bit input area	3 - 17
3.4.2	Word input area	3 - 19
3.4.3	Bit output area	3 - 19
3.5	Memory and Parameters	3 - 20
3.5.1	Memory	3 - 20
3.5.2	Parameters	3 - 21

CHAPTER4 SETUP AND PROCEDURES BEFORE OPERATION **4 - 1 to 4 - 15**

4.1	Handling Precautions	4 - 1
4.2	Setup and Procedure before Operation	4 - 2
4.3	Part Names	4 - 3
4.3.1	Status confirmation by LEDs	4 - 4
4.4	Wiring	4 - 5
4.4.1	Wiring precautions	4 - 5
4.4.2	External wiring	4 - 6
4.5	Offset/Gain Settings	4 - 9

CHAPTER5 GX Configurator-ST **5 - 1 to 5 - 11**

5.1	GX Configurator-ST Functions	5 - 1
5.2	Creating a project	5 - 2
5.3	Parameter Setting	5 - 3
5.4	Input/Output Monitor	5 - 6
5.5	Forced Output Test	5 - 8
5.6	Offset/Gain Setting	5 - 10

CHAPTER6 PROGRAMMING **6 - 1 to 6 - 28**

6.1	Programming Procedure	6 - 1
6.2	System Configuration Example	6 - 4
6.3	Settings and Communication Data	6 - 5
6.4	Program Examples	6 - 9

CHAPTER7 ONLINE MODULE CHANGE **7 - 1 to 7 - 11**

7.1	Precautions for Online Module Change	7 - 1
7.2	Preparations for Online Module Change	7 - 3
7.3	Disconnecting/connecting the External Device for Online Module Change	7 - 4
7.4	Online Module Change Procedure	7 - 4
7.4.1	When setting is performed using GX Configurator-ST during online module change	7 - 4

8.1	Command List	8 - 1
8.2	Common Commands.....	8 - 5
8.2.1	Operating status read request (Command No.: 8100H/0100H).....	8 - 5
8.2.2	Error code read request (Command No.: 8101H/0101H)	8 - 7
8.3	Initial Data Write Command.....	8 - 9
8.3.1	Initial data batch write request (Command No.: 8106H).....	8 - 9
8.3.2	Initial data individual write request (Command No.: 8107H/0107H).....	8 - 12
8.4	ST1AD Parameter Setting Read Commands.....	8 - 15
8.4.1	A/D conversion enable/disable setting read (Command No.: 9100H/1100H)	8 - 15
8.4.2	A/D conversion channel read (Command No.: 9101H/1101H).....	8 - 17
8.4.3	Operation condition setting read (Command No.: 9102H/1102H)	8 - 19
8.4.4	Notch filter setting read (Command No.: 9103H/1103H)	8 - 22
8.4.5	CH [] time/count averaging setting read (Command No.: 9104H/1104H)	8 - 24
8.4.6	CH [] upper upper limit/upper lower limit setting read (Command No.: 9108H,910AH/1108H,110AH)	8 - 26
8.4.7	CH [] lower upper limit/lower lower limit setting read (Command No.: 9109H, 910BH/1109H, 110BH).....	8 - 28
8.4.8	Input range setting read (Command No.: 9118H/1118H)	8 - 30
8.5	ST1AD Parameter Setting Write Commands.....	8 - 33
8.5.1	A/D conversion enable/disable setting write (Command No.: A100H/2100H).....	8 - 33
8.5.2	Operating condition setting write (Command No.: A102H/2102H)	8 - 36
8.5.3	Notch filter setting write (Command No.: A103H/2103H).....	8 - 39
8.5.4	CH [] time/count averaging setting write (Command No.: A104H/2104H).....	8 - 42
8.5.5	CH [] upper upper limit/upper lower limit setting write (Command No.: A108H, A10AH/2108H,210AH).....	8 - 45
8.5.6	CH [] lower upper limit/lower lower limit setting write (Command No.: A109H, A10BH/2109H, 210BH)	8 - 48
8.6	ST1AD Control Commands	8 - 51
8.6.1	Parameter setting read from ROM (Command No.: B100H/3100H)	8 - 51
8.6.2	Parameter setting write to ROM (Command No.: B101H/3101H)	8 - 53
8.6.3	Operation mode setting (Command No.: B102H/3102H).....	8 - 55
8.6.4	Offset channel specification (Command No.: B103H/3103H)	8 - 57
8.6.5	Gain channel specification (Command No.: B104H/3104H).....	8 - 60
8.6.6	User range write (Command No.: B105H/3105H)	8 - 63
8.7	Values Stored into Command Execution Result	8 - 65

9.1	Error Code List	9 - 1
9.2	Troubleshooting	9 - 4
9.2.1	When the RUN LED is flashing or turned off.....	9 - 4
9.2.2	When the RUN and ERR. LEDs turned on.....	9 - 5
9.2.3	When digital output values cannot be read.....	9 - 6

APPENDIX**App - 1 to App - 3**

Appendix 1	Accessories	App - 1
Appendix 2	External Dimensions	App - 2

INDEX**Index - 1 to Index - 2**

About Manuals

The following manuals are related to this product.
Referring to this list, please request the necessary manuals.

Relevant Manuals

Manual Name	Manual Number (Model Code)
MELSEC-ST System User's Manual Explains the system configurations of the MELSEC-ST system and the performance specifications, functions, handling, wiring and troubleshooting of the power distribution modules, base modules and I/O modules. (Sold separately)	SH-080456ENG (13JR72)
MELSEC-ST CC-Link Head Module User's Manual Explains the system configurations, specifications, functions, handling, wiring and troubleshooting of the ST1H-BT. (Sold separately)	SH-080754ENG (13JR68)
GX Configurator-ST Version 1 Operating Manual Explains how to operate GX Configurator-ST, how to set the intelligent function module parameters, and how to monitor the MELSEC-ST system. (Sold separately)	SH-080439ENG (13JU47)
CC-Link System Master/Local Module User's Manual Describes the system configurations, performance specifications, functions, handling, wiring and troubleshooting of the QJ61BT11N. (Sold separately)	SH080394E (13JR64)

Compliance with the EMC and Low Voltage Directives

(1) For MELSEC-ST system

To configure a system meeting the requirements of the EMC and Low Voltage Directives when incorporating the Mitsubishi MELSEC system (EMC and Low Voltage Directives compliant) into other machinery or equipment, refer to Chapter 11 "EMC AND LOW VOLTAGE DIRECTIVES" of the MELSEC-ST System User's Manual. The CE mark, indicating compliance with the EMC and Low Voltage Directives, is printed on the rating plate of the MELSEC-ST system.

(2) For this product

No additional measures are necessary for the compliance of this product with the EMC and Low Voltage Directives.

How to Read Manual

This manual explains each area for the CC-Link remote I/O, remote registers, and message transmission using **Br**, **Wr**, **Cr**, **Bw**, **Ww**, and **Cw**.

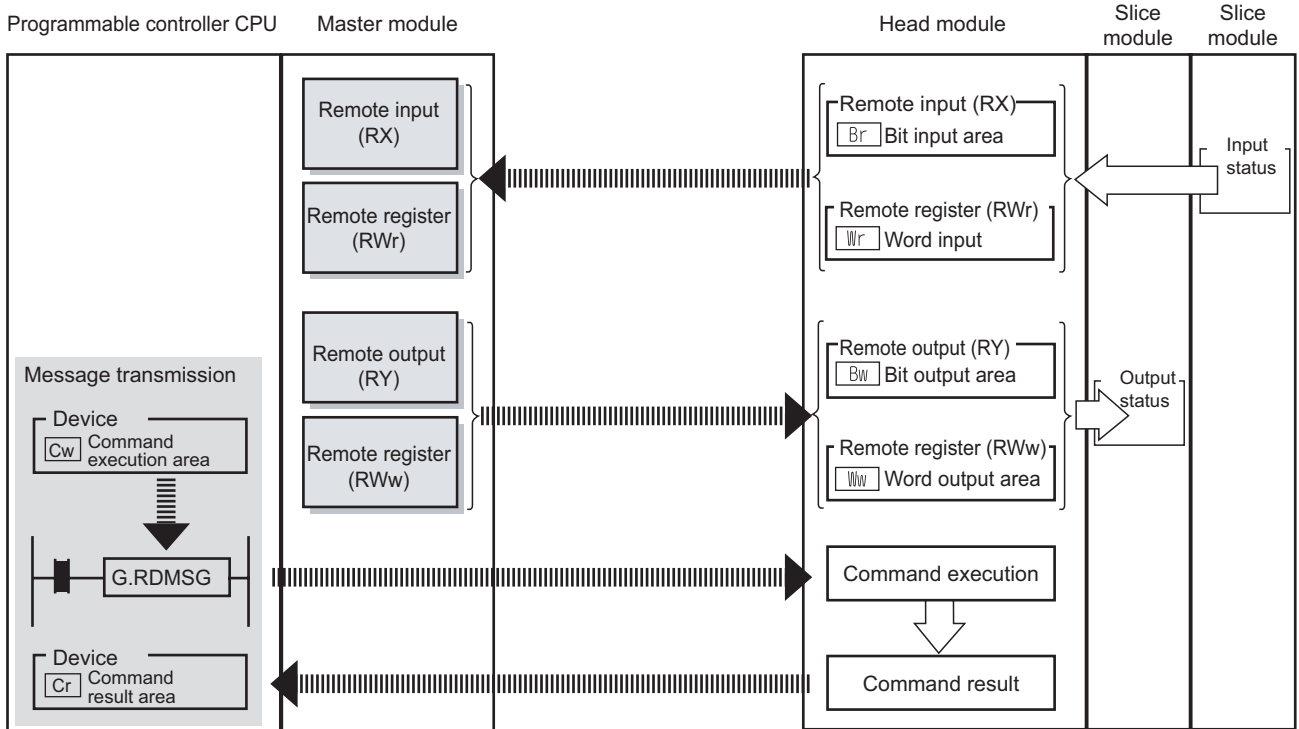
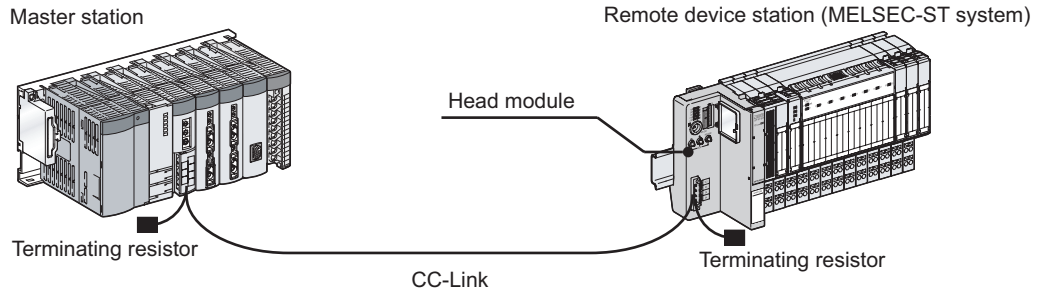

(1) Data symbol

<Example of **Cr** Command result area>

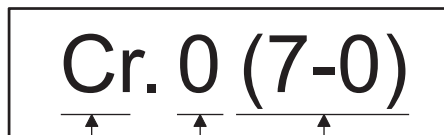

Range
When the unit of data is one word (16 bits),
the corresponding bits are indicated.
(0): Bit 0 (7-0): Range of bit 0 to bit 7

Detail data No.

Abbreviated data symbol

((2) Head module→Master station, (3) Master station→Head module)

(2) Head module → Master station

(a) Remote input (RX)

Data symbol	Area	Unit	Detail data No. notation
Br	Br.00 to Br.n	Bit Input Area	1 bit/symbol Hexadecimal

(b) Remote register (RWr)

Data symbol	Area	Unit	Detail data No. notation
Wr	Wr.00 to Wr.n	Word Input Area	1 word/symbol Hexadecimal

(c) Message transmission

Data symbol	Area	Unit	Detail data No. notation
Cr	Cr.0 to Cr.n	Command Result Area	1 word/symbol Decimal

(3) Master station → Head module

(a) Remote output (RY)

Data symbol	Area	Unit	Detail data No. notation
Bw	Bw.00 to Bw.n	Bit output Area	1 bit/symbol Hexadecimal

(b) Remote register (RWw)

Data symbol	Area	Unit	Detail data No. notation
Ww	Ww.00 to Ww.n	Word output Area	1 word/symbol Hexadecimal

(c) Message transmission

Data symbol	Area	Unit	Detail data No. notation
Cw	Cw.0 to Cw.n	Command execution Area	1 word/symbol Decimal

Generic Terms and Abbreviations

This manual uses the following generic terms and abbreviations to describe the ST1AD, unless otherwise specified.

Generic Term/ Abbreviation	Description
ST1AD2-V	Abbreviation for ST1AD2-V MELSEC-ST analog-digital converter module.
ST1AD2-I	Abbreviation for ST1AD2-I MELSEC-ST analog-digital converter module.
ST1AD	Generic term for ST1AD2-V and ST1AD2-I.
Head module	ST1H-BT, MELSEC-ST CC-Link head module.
Bus refreshing module	Module that distributes external system power and auxiliary power to the head module and slice modules.
Power feeding module	Module that distributes external auxiliary power to slice modules.
Power distribution module	Generic term for bus refreshing module and power feeding module.
Base module	Module that transfers data/connects between the head module and slice modules, and between slice modules and external devices.
Input module	Module that handles input data in bit units.
Output module	Module that handles output data in bit units.
Intelligent function module	Module that handles input/output data in word units.
I/O module	Input module and output module.
Slice module	Module that can be mounted to the base module: power distribution module, I/O module and intelligent function module.
MELSEC-ST system	System that consists of head module, slice modules, end plates and end brackets.
GX Configurator-ST	Configuration software dedicated to the MELSEC-ST system. The general name of SWnD5C-STPB-E type products.(n=1 or later)
CC-Link	Abbreviation for Control and Communication Link system.
Master module	Abbreviation for the QJ61BT11N when it is used as a master station.
RDMSG	Abbreviation for dedicated instruction of master station.

Term definition

The following explains the meanings and definitions of the terms used in this manual.

Term	Definition
Cyclic transmission	A communication method by which remote I/O data and remote register data are transferred periodically.
Message transmission	A transmission method for writing parameters from the master station to a remote device station and reading the remote device station status.
Master station	This station controls the entire data link system. One master station is required for one system.
Remote I/O station	A remote station that can only use bit data. (Input from or output to external devices) (AJ65BTB1-16D, AJ65SBTB1-16D, etc.)
Remote device station	A remote station that can use both bit and word data. (Input from or output to external devices, or analog data conversion) (ST1H-BT, AJ65BT-64AD, AJ65BT-64DAV, AJ65BT-64DAI, etc.)
SB	Link special relay (for CC-Link). Bit data that indicate the module operating status and data link status of the master/local station.
SW	Link special register (for CC-Link) Data in units of 16 bits, which indicate the module operating status and data link status of the master/local station.
RX	Remote input (for CC-Link). Bit data that are input from remote stations to the master station.
RY	Remote output (for CC-Link) Bit data that are output from the master station to remote stations.
RWr	Remote register. (CC-Link data read area) 16-bit word data that are input from remote device stations to the master station.
RWw	Remote register. (CC-Link data write area) 16-bit word data that are output from the master station to remote device stations.
Remote net Ver.1 mode	Select this mode when extended cyclic setting is not needed or when the QJ65BT11 is replaced with the QJ65BT11N.
Remote net Ver.2 mode	Select this mode when creating a new system with extended cyclic setting.
I/O data	Data that are sent/received between the head module and the master station. Generic term for RX, RY, RWr, and RWw.
<input type="checkbox"/> Br.n bit input area	Bit input data of each module. Input data are sent from the head module to the master station through the remote input (RX).
<input type="checkbox"/> Bw.n bit output area	Bit output data of each module. Output data are sent from the master station and received to the head module through the remote output (RY).
<input type="checkbox"/> Wr.n word input area	Word (16-bit) input data of an intelligent function module. Input data are sent from the head module to the master station through the remote register (RWr).
<input type="checkbox"/> Ww.n word output area	Word (16-bit) output data of an intelligent function module. Output data are sent from the master station and received to the head module through the remote register (RWw).
<input type="checkbox"/> Cr.n command result area	An area for the information that indicates a command result. This information is stored in Setting data ((D1)+1 and after) of the RDMSG instruction of the master station.
<input type="checkbox"/> Cw.n command execution area	An area for the information for executing a command. This information is stored in Setting data ((S2)+1 and after) of the RDMSG instruction of the master station.

Term	Definition
Number of occupied I/O points	The area, that is equivalent to the occupied I/O points, is occupied in <input type="text" value="Br"/> bit input area/ <input type="text" value="Bw"/> bit output area.
Slice No.	The number assigned to every 2 occupied I/O points of each module. The numbers are assigned in ascending order, starting from "0" of the head module. (The maximum value is 127). This is used for specifying a command execution target.
Slice position No.	The number that shows where the slice module is physically installed. The numbers are assigned in ascending order, starting from "0" of the head module. (The maximum value is 63.) This is used for specifying a command execution target.
Start slice No.	The start slice No. assigned to the head module and slice modules.
Command	Generic term for requests that are executed by the master station for reading each module's operation status, setting intelligent function module command parameters or various controls.
Command parameter	Generic term for parameters set in commands or GX Configurator-ST. All of the parameters set for the head module and slice modules are command parameters.

Packing list

One of the following ST1AD products is included.

Model name	Product name	Quantity
ST1AD2-V	ST1AD2-V MELSEC-ST analog-digital converter module	1
ST1AD2-I	ST1AD2-I MELSEC-ST analog-digital converter module	1

CHAPTER1 OVERVIEW

This User's Manual provides the specifications, handling, programming methods, etc. for the ST1AD2-V type MELSEC-ST analog-digital converter module (hereinafter referred to as the ST1AD2-V) and ST1AD2-I type MELSEC-ST analog-digital converter module (hereinafter referred to as the ST1AD2-I).

In this manual, the ST1AD2-V and ST1AD2-I are collectively referred to as the ST1AD. This manual describes only the ST1AD.

For information on the MELSEC-ST system, refer to the MELSEC-ST System User's Manual.

1.1 Features

(1) Available models

- ST1AD2-V..... 2-channel voltage input type.
- ST1AD2-I..... 2-channel current input type.

(2) Up to 26 modules can be mounted

For one head module, up to 26 ST1AD modules (52 channels) can be mounted.

(3) Input range can be changed for each channel

The analog input range^{*1} can be changed for each channel to change the I/O conversion characteristic.

^{*1} The input range refers to the type of offset/gain settings. The most frequently used range is set as the default, but the user can make offset/gain settings according to the purpose.

(4) Alarm output function

If a digital output value falls outside a setting range, an alarm is output for each channel.

(5) Disconnection detection function

Cable disconnection is detected for each channel.

(6) Notch filter processing

Notch filter processing removes the power supply noise (50Hz/60Hz) of external devices. (Within -60dB)

(7) Command function

By writing command parameters to the ROM using a command, A/D conversion can be made without setting the command parameters at module start (power-on).

(8) High-speed conversion processing

Conversion speed is as high as 0.1ms/channel when notch filter processing is not performed, or 0.2ms/channel when notch filter processing is performed.

(9) High degree of accuracy

This module performs A/D conversion at the accuracy of $\pm 0.8\%$ relative to the maximum digital output value.

(10) Online module change

A module can be replaced without stopping the system.

(11) Easy setting using GX Configurator-ST

A software package (GX Configurator-ST) is separately available.

GX Configurator-ST is not necessarily required for the system.

However, using GX Configurator-ST enables onscreen parameter setting and offset/gain setting, which can reduce programming steps of master station and makes the setting/operating status check easier.

CHAPTER2 SYSTEM CONFIGURATION

This chapter describes the system configuration for use of the ST1AD.

2.1 Overall Configuration

The overall configuration for use of the ST1AD is shown below.

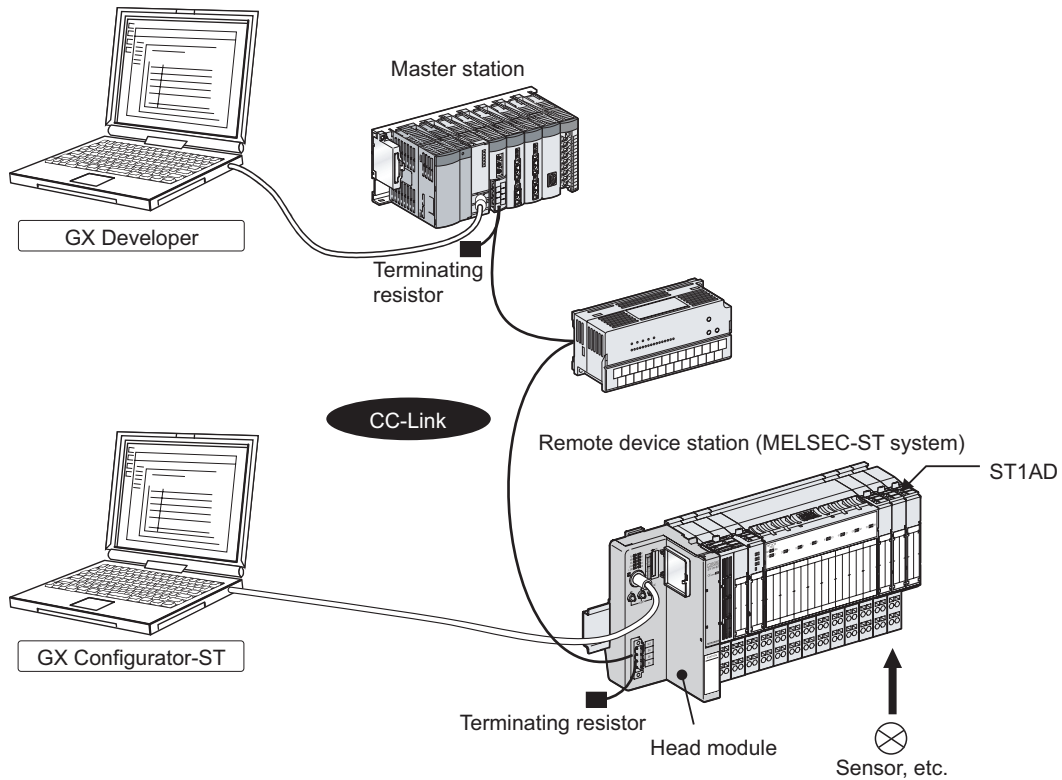

Figure 2.1 Overall system configuration

2.2 Applicable System

This section explains the applicable system.

2.2.1 Applicable head module

The head module applicable to the ST1AD is indicated below.

Table 2.1 Applicable head module

Product name	Model name
MELSECT-ST CC-Link Head Module	ST1H-BT

2.2.2 Applicable base module

The base modules applicable to the ST1AD are indicated below.

Table 2.2 Applicable base module

Type	Model name
Spring Clamp Type	ST1B-S4IR2
Screw Clamp Type	ST1B-E4IR2

2.2.3 Applicable coding element

The coding elements applicable for the ST1AD are indicated below.

The coding element is fitted before shipment.

It is also available as an option in case it is lost.

Table 2.3 Applicable coding element

Description	Model name
ST1AD2-V coding element	ST1A-CKY-13
ST1AD2-I coding element	ST1A-CKY-14

2.2.4 Applicable software package

The software package applicable to the ST1AD is indicated below.

Table 2.4 Applicable software package

Product name	Model name	Version
GX Configurator-ST *1	SW1D5C-STPB-E	1.06G or later

* 1 GX Configurator-ST is optional.

2.3 Precautions for System Configuration

For precautions for ST1AD system configuration, refer to the following.

☞ MELSEC-ST System User's Manual, "3.4 Precautions for System Configuration"

2.4 Checking Hardware and Software Versions

The hardware and software versions of the ST1AD can be checked on the DATE section on the rating plate, which is situated on the side of the module.

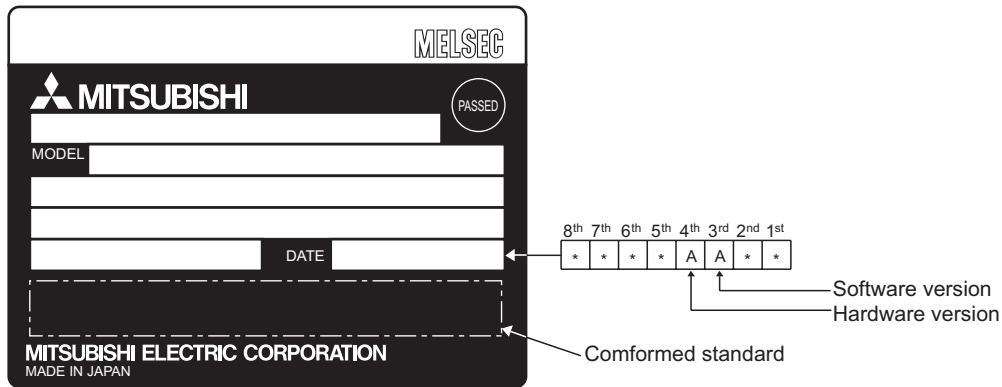

Figure 2.2 Rating plate

CHAPTER3 SPECIFICATIONS

This chapter provides the specifications of the ST1AD.
For the general specifications of the ST1AD, refer to the following.

☞ MELSEC-ST System User's Manual

3.1 Performance Specifications

The following indicates the performance specifications of the ST1AD.

Table 3.1 Performance specifications list

Item		Specifications																							
Model name		ST1AD2-V	ST1AD2-I																						
Analog input points		2 points (2 channels/module)																							
Analog input	Voltage	-10 to 10V DC (Input resistance value: 1MΩ)	-																						
	Current	-	0 to 20mA (Input resistance value: 250Ω)																						
Digital output		16-bit signed binary (-4096 to 4095)	16-bit signed binary (-96 to 4095)																						
I/O characteristics, Maximum resolution		<table border="1"> <thead> <tr> <th>Analog input range</th> <th>Digital output value</th> <th>Maximum resolution</th> </tr> </thead> <tbody> <tr> <td rowspan="4">ST1AD2-V (Voltage)</td> <td>0 to 10 V</td> <td rowspan="2">0 to 4000</td> <td>2.5 mV</td> </tr> <tr> <td>0 to 5 V</td> <td>1.25 mV</td> </tr> <tr> <td>-10 to 10V</td> <td rowspan="2">-4000 to 4000</td> <td>2.5 mV</td> </tr> <tr> <td>User range setting</td> <td>1.0 mV</td> </tr> <tr> <td rowspan="3">ST1AD2-I (Current)</td> <td>0 to 20 mA</td> <td rowspan="3">0 to 4000</td> <td>5μA</td> </tr> <tr> <td>4 to 20 mA</td> <td>4μA</td> </tr> <tr> <td>User range setting</td> <td>4μA</td> </tr> </tbody> </table>		Analog input range	Digital output value	Maximum resolution	ST1AD2-V (Voltage)	0 to 10 V	0 to 4000	2.5 mV	0 to 5 V	1.25 mV	-10 to 10V	-4000 to 4000	2.5 mV	User range setting	1.0 mV	ST1AD2-I (Current)	0 to 20 mA	0 to 4000	5μA	4 to 20 mA	4μA	User range setting	4μA
		Analog input range	Digital output value	Maximum resolution																					
		ST1AD2-V (Voltage)	0 to 10 V	0 to 4000	2.5 mV																				
			0 to 5 V		1.25 mV																				
			-10 to 10V	-4000 to 4000	2.5 mV																				
			User range setting		1.0 mV																				
		ST1AD2-I (Current)	0 to 20 mA	0 to 4000	5μA																				
			4 to 20 mA		4μA																				
User range setting	4μA																								
Accuracy *1 (Accuracy in respect to maximum digital output value)	Ambient temperature 0 to 55 °C	Within ± 0.8 % (± 32digit)																							
Conversion speed		When notch filter processing is not performed: 0.1 ms/channel When notch filter processing is performed: 0.2 ms/channel																							
Absolute maximum input	Voltage	± 15 V	-																						
	Current	-	± 30 mA																						
ROM write count		ROM write count by user range write or parameter setting: Maximum 10,000 times																							
Number of occupied I/O points		4 points for each of input and output																							
Number of Occupied Slices		2																							
Information amount	Input data	Br.n : Number of input data: 4, Wr.n : Number of input data: 2																							
	Output data	Bw.n : Number of output data: 4, Ww.n : Number of output data: 0																							
Isolation specifications		<table border="1"> <thead> <tr> <th>Specific isolated area</th> <th>Isolation method</th> <th>Dielectric withstand</th> <th>Insulation resistance</th> </tr> </thead> <tbody> <tr> <td>Between analog input terminals and internal bus</td> <td>Photo coupler insulation</td> <td>560V AC rms/3 cycles (elevation 2000m)</td> <td>500V DC 10MΩ or more</td> </tr> <tr> <td>Between analog input channels</td> <td>No insulation</td> <td>-</td> <td>-</td> </tr> </tbody> </table>		Specific isolated area	Isolation method	Dielectric withstand	Insulation resistance	Between analog input terminals and internal bus	Photo coupler insulation	560V AC rms/3 cycles (elevation 2000m)	500V DC 10MΩ or more	Between analog input channels	No insulation	-	-										
		Specific isolated area	Isolation method	Dielectric withstand	Insulation resistance																				
		Between analog input terminals and internal bus	Photo coupler insulation	560V AC rms/3 cycles (elevation 2000m)	500V DC 10MΩ or more																				
Between analog input channels	No insulation	-	-																						
Applicable base module		Spring clamp type: ST1B-S4IR2, Screw clamp type: ST1B-E4IR2																							
Applicable coding element		ST1A-CKY-13 (green)	ST1A-CKY-14 (green)																						
External AUX. power supply		24V DC (+20/-15%, ripple ratio within 5%) 24V DC current: 0.030A																							
5V DC internal current consumption		0.110 A																							
External dimensions		77.6 (3.06in.) (H) × 12.6 (0.50in.) (w) × 55.4 (2.18in.) (D) [mm]																							
Weight		0.04 kg																							

* The ST1AD needs to be powered on 5 minutes prior to operation for compliance to the specification (accuracy).

3.2 I/O Conversion Characteristics

An I/O conversion characteristic indicates an inclination of a straight line that connects an offset value and a gain value at the time when an analog value (voltage or current input) from an external device is converted into a digital value.

The offset value is an analog input value (voltage or current) at which the digital output value is 0.

The gain value is an analog input value (voltage or current) at which the digital output value is 4000.

3.2.1 Input characteristics of ST1AD2-V

A graph of the ST1AD2-V input characteristic is shown below.

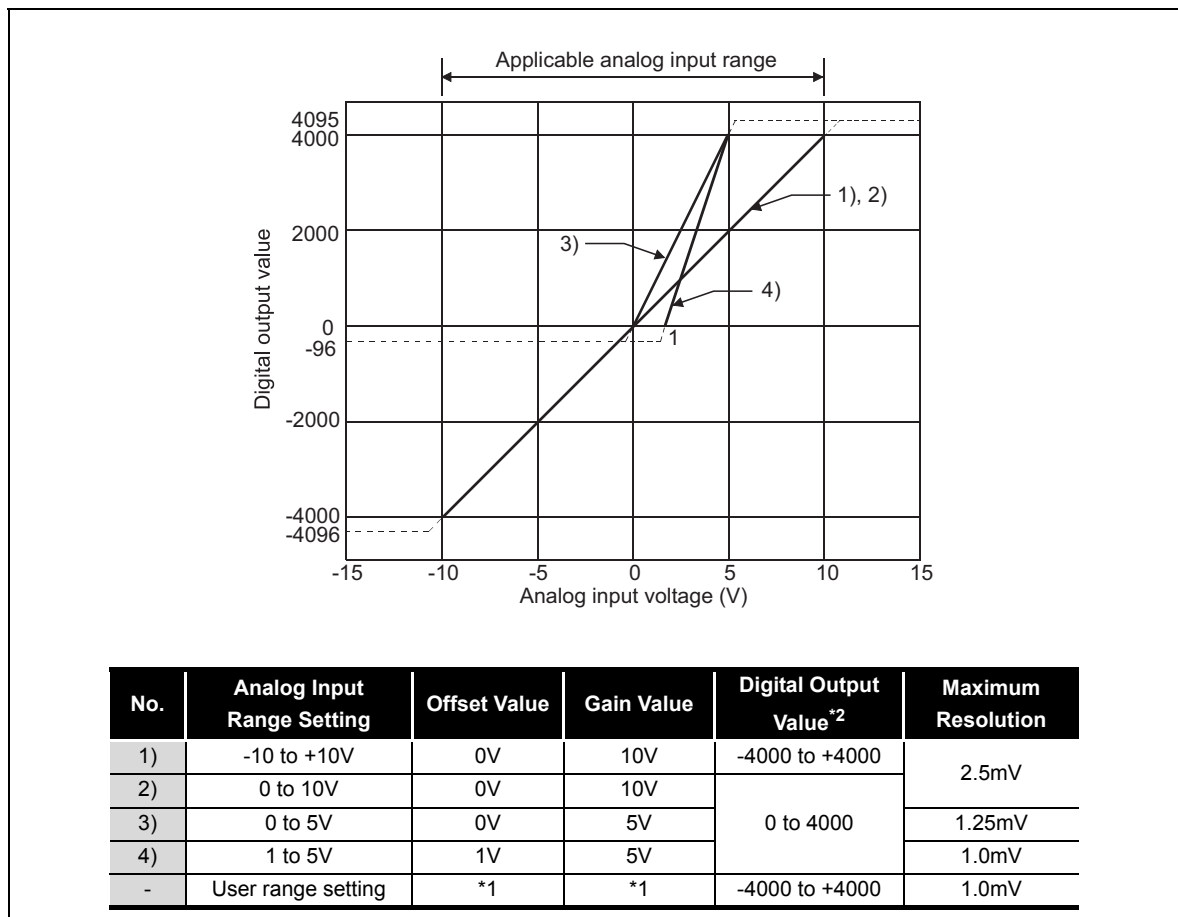

Figure 3.1 Input characteristics of ST1AD2-V

* 1 refer to the following POINT(3)

* 2 refer to the following POINT(4)

POINT

- (1) Within the analog input and digital output scopes of each input range, the maximum resolution and accuracy are within the performance specification range. Outside those scopes, however, they may not fall within the performance specification range. (Avoid using the dotted line part in Figure 3.1.)
- (2) Do not input more than $\pm 15V$. The element may be damaged.
- (3) Set the offset/gain values for the user setting range *1 within a range in which the following conditions are satisfied.
 - (a) (Setting range): -10 to 10V
 - (b) (Gain value) > (Offset value)
 - (c) (Gain value) - (Offset value) $\geq 4V$

If condition (b) is not satisfied, ERR.LED turns on, the value will not be written to the module.

When the setting is outside the condition in (c), conversion is made but the resolution is within the maximum resolution range of the performance specifications.
- (4) When an analog value that exceeds the range for the digital output value *2 is entered, the digital output value will be fixed at the maximum or minimum value.
 - For 0 to 4000, the digital output value is within the range -96 to 4095.
 - For -4000 to +4000, the digital output value is within the range -4096 to 4095.

3.2.2 Input characteristics of ST1AD2-I

A graph of the ST1AD2-I input characteristic is shown below.

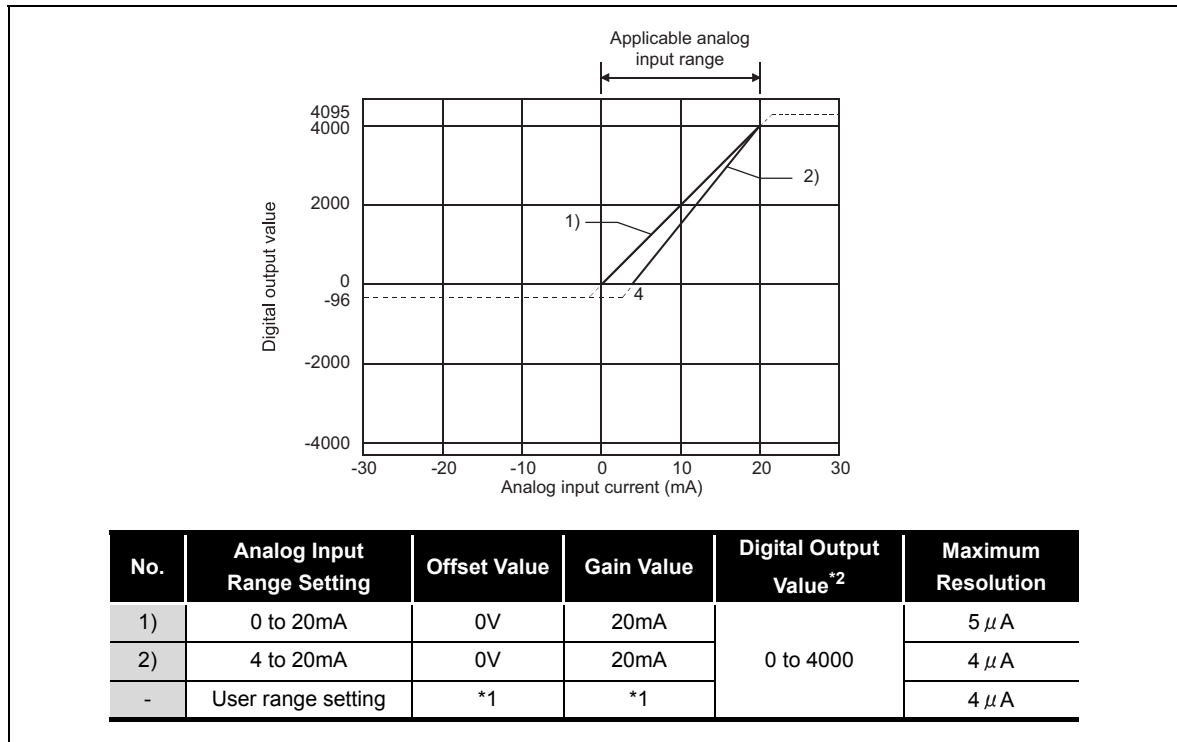

Figure 3.2 Input characteristics of ST1AD2-I

* 1 refer to the following POINT(3)

* 2 refer to the following POINT(4)

POINT

- (1) Within the analog input and digital output scopes of each input range, the maximum resolution and accuracy are within the performance specification range. Outside those scopes, however, they may not fall within the performance specification range. (Avoid using the dotted line part in Figure 3.1.)
- (2) Do not input more than ± 30 mA. The element may be damaged.
- (3) Set the offset/gain values for the user setting range *1 within a range in which the following conditions are satisfied.
 - (a) (Setting range): 0 to 20mA
 - (b) (Gain value) > (Offset value)
 - (c) (Gain value) - (Offset value) ≥ 16 mA

If condition (b) is not satisfied, ERR.LED turns on, the value will not be written to the module.

When the setting is outside the condition in (c), conversion is made but the resolution is within the maximum resolution range of the performance specification.
- (4) When an analog value that exceeds the range for the digital output value *2 is entered, the digital output value will be fixed at the maximum or minimum value.
 - For 0 to 4000, the digital output value is within the range -96 to 4095.

3.2.3 Relation between the offset/gain setting and digital output value

The relation between the offset/gain setting and digital output value is described.

(1) Resolution

The resolution is obtained by the following formula:

$$\text{Resolution} = \frac{(\text{Gain value}) - (\text{Offset value})}{4000}$$

(2) Relation between the maximum resolution and digital output value

The maximum resolution of the ST1AD is as indicated in the performance specification.

If the following is satisfied from the offset/gain setting, the digital output value does not increase /decreases by one.

$$\frac{(\text{Gain value}) - (\text{Offset value})}{4000} < \text{Maximum resolution}$$

3.2.4 Accuracy

Accuracy is relative to the maximum value of the digital output value (4000).
If you change the offset/gain setting or input range to change the input characteristic, accuracy does not change and is held within the range indicated in the performance specifications.

Accuracy is within $\pm 0.8\%$ (± 32 digit).

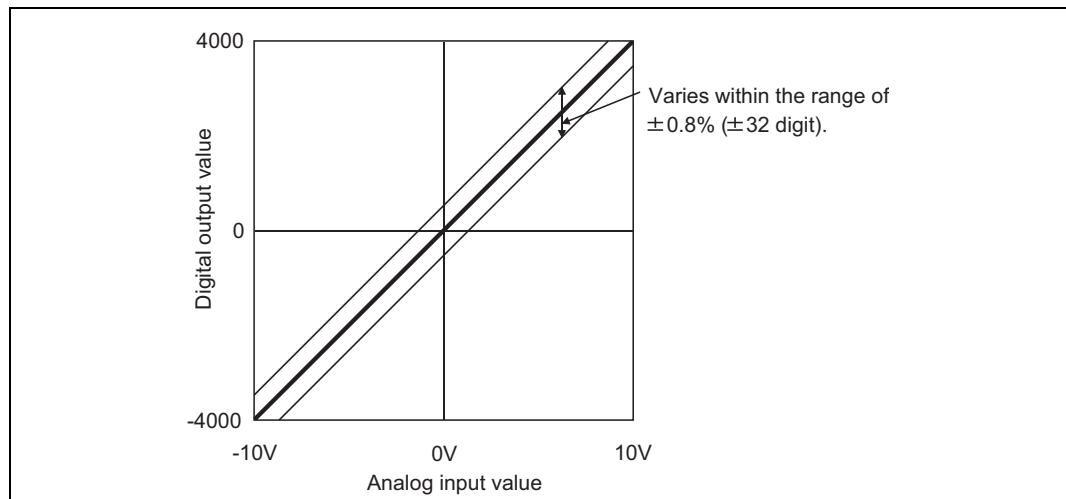

Figure 3.3 Accuracy of ST1AD2-V

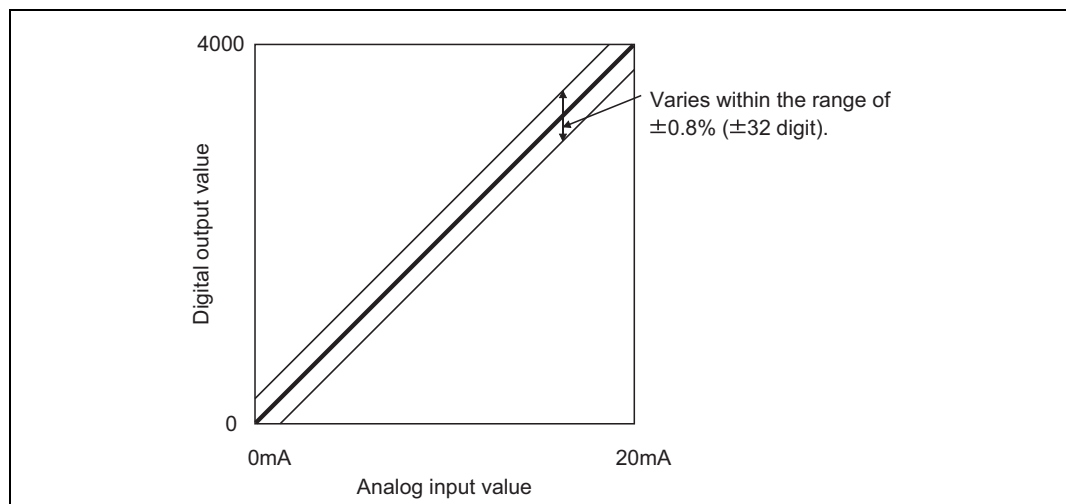

Figure 3.4 Accuracy of ST1AD2-I

3.2.5 Conversion speed

The conversion speed of the ST1AD changes depending on whether notch filter processing is performed or not.

- (a) When notch filter processing is not performed
(Conversion speed) = $0.1\text{ms} \times \text{number of conversion enabled channels}$
- (b) When notch filter processing is performed
(Conversion speed) = $0.2\text{ms} \times \text{number of conversion enabled channels}$

3.2.6 Intelligent function module processing time

The intelligent function module processing time of the ST1AD changes depending on whether notch filter processing is performed or not.

- (a) When notch filter processing is not performed
(Processing time) = $0.1\text{ms} \times \text{number of conversion enabled channels}$
- (b) When notch filter processing is performed
(Processing time) = $0.2\text{ms} \times \text{number of conversion enabled channels}$

For the input transmission delay time, refer to the used head module user's manual.

3.3 Functions

This section explains the functions of the ST1AD.

3.3.1 Function list

Table 3.2 lists the functions of the ST1AD.

Table 3.2 ST1AD function list



















Item	Description	Reference section												
A/D conversion enable/disable function	<p>(1) Specifies whether to enable or disable the A/D conversion for each channel. (2) By default, A/D conversion for all channels is enabled. [Setting method]</p> <ul style="list-style-type: none"> GX Configurator-ST  Section 5.3 Parameter Setting Dedicated instruction (RDMSG) from the master station  Section 8.4.1 A/D conversion enable/disable setting read (Command No.: 9100H/1100H) 	-												
A/D conversion method	<p>(1) Sampling process The input analog value is converted to digital value for each channel and the digital value is output.</p> <p>(2) Averaging process The A/D conversion is performed for the specified channel as many times as the setting or for the set time. Then the sum of the values other than the maximum and minimum ones is averaged and output to the digital value.</p> <p>(3) Averaging process setting defaults to Sampling process performed on all channels. (4) Time averaging defaults to 4ms, and number of times averaging defaults to 4 times. [Averaging process specifying method]</p> <ul style="list-style-type: none"> GX Configurator-ST  Section 5.3 Parameter Setting Dedicated instruction (RDMSG) from the master station  Section 8.5.2 Operating condition setting write (Command No.: A102H/2102H) <p>[Average time/average number of times setting method]</p> <ul style="list-style-type: none"> GX Configurator-ST  Section 5.3 Parameter Setting Dedicated instruction (RDMSG) from the master station  Section 8.5.4 CH [] time/count averaging setting write (Command No.: A104H/2104H) 	Section 3.3.2												
Input range changing function	<p>(1) The analog input range can be set for each channel to change the I/O conversion characteristics. (2) The input range is selectable from the following.</p> <table border="1" data-bbox="571 1572 1090 1854"> <thead> <tr> <th>Model</th> <th>Input range</th> </tr> </thead> <tbody> <tr> <td rowspan="5">ST1AD2-V</td> <td>-10 to 10V (default)</td> </tr> <tr> <td>0 to 10V</td> </tr> <tr> <td>0 to 5V</td> </tr> <tr> <td>1 to 5V</td> </tr> <tr> <td>User range setting</td> </tr> <tr> <td rowspan="3">ST1AD2-I</td> <td>4 to 20mA (default)</td> </tr> <tr> <td>0 to 20 mA</td> </tr> <tr> <td>User range setting</td> </tr> </tbody> </table> <p>[Setting method]</p> <ul style="list-style-type: none"> GX Configurator-ST  Section 5.3 Parameter Setting Dedicated instruction (RDMSG) from the master station  Section 8.3.1 Initial data batch write request (Command No.: 8106H)  Section 8.3.2 Initial data individual write request (Command No.: 8107H/0107H) 	Model	Input range	ST1AD2-V	-10 to 10V (default)	0 to 10V	0 to 5V	1 to 5V	User range setting	ST1AD2-I	4 to 20mA (default)	0 to 20 mA	User range setting	-
Model	Input range													
ST1AD2-V	-10 to 10V (default)													
	0 to 10V													
	0 to 5V													
	1 to 5V													
	User range setting													
ST1AD2-I	4 to 20mA (default)													
	0 to 20 mA													
	User range setting													

Table 3.2 ST1AD function list

Item	Description	Reference section
Alarm output function	<p>(1) If a digital output value falls outside a setting range, an alarm is output for each channel.</p> <p>(2) Alarm output setting is No alarm output processing on all channels by default.</p> <p>(3) Set the alarm output in 4 steps: upper upper limit value, upper lower limit value, lower upper limit value and lower lower limit value. The upper upper limit value and upper lower limit value are set to 4000 by default. The lower upper limit value and lower lower limit value are set to -4000 for the ST1AD2-V and 0 for the ST1AD2-I by default.</p> <p>[Alarm output setting method]</p> <ul style="list-style-type: none"> • GX Configurator-ST  Section 5.3 Parameter Setting • Dedicated instruction (RDMSG) from the master station <p> Section 8.5.2 Operating condition setting write (Command No.: A102H/2102H)</p> <p>[Upper upper limit value, upper lower limit value, lower upper limit value and lower lower limit value setting method]</p> <ul style="list-style-type: none"> • GX Configurator- ST  Section 5.3 Parameter Setting • Dedicated instruction (RDMSG) from the master station <p> Section 8.5.5 CH [] upper upper limit/upper lower limit setting write (Command No.: A108H, A10AH/2108H,210AH)</p> <p> Section 8.5.6 CH [] lower upper limit/lower lower limit setting write (Command No.: A109H, A10BH/2109H, 210BH)</p>	Section 3.3.3
Disconnection detection function	<p>(1) For the range of 1 to 5V or 4 to 20mA, cable disconnection can be detected for each channel.</p> <p>(2) The setting for this function is No disconnection detection on all channels by default.</p> <p>[Setting method]</p> <ul style="list-style-type: none"> • GX Configurator- ST  Section 5.3 Parameter Setting • Dedicated instruction (RDMSG) from the master station <p> Section 8.5.2 Operating condition setting write (Command No.: A102H/2102H)</p>	Section 3.3.4
Notch filter processing	<p>(1) Notch filter processing removes the power supply noise (50Hz/60Hz) of external devices. (Within -60dB) Use this function when the module seems to be affected by power supply noise.</p> <p>(2) Notch filter processing is batch-performed for all channels.</p> <p>(3) Notch filter processing can be used independently of sampling processing and averaging processing.</p> <p>(4) Select notch filter processing from among the following types.</p> <ul style="list-style-type: none"> • No notch filter processing performed on all channels • Notch filter processing performed on all channels (50±3Hz) • Notch filter processing performed on all channels (60±3Hz) <p>(5) Defaults to No notch filter processing performed on all channels.</p> <p>[Setting method]</p> <ul style="list-style-type: none"> • GX Configurator- ST  Section 5.3 Parameter Setting • Dedicated instruction (RDMSG) from the master station <p> Section 8.4.3 Operation condition setting read (Command No.: 9102H/1102H)</p>	-
Command	<p>(1) By using commands, command parameters can be set, and the parameter settings can be written from RAM to ROM and read from ROM to RAM.</p>	CHAPTER 8
Offset/gain settings	<p>(1) Setting of any offset value/gain value optimizes the I/O conversion characteristic according to the system.</p> <p>[Setting method]</p> <ul style="list-style-type: none"> • GX Configurator-ST • Dedicated instruction (RDMSG) from the master station 	Section 4.5 Section 5.6
Online module change	<p>(1) A module can be replaced without stopping the system.</p> <p>[Execution procedure]</p> <ul style="list-style-type: none"> • GX Configurator-ST • Button operation of the head module 	CHAPTER 7

1	OVERVIEW
2	SYSTEM CONFIGURATION
3	SPECIFICATIONS
4	SETUP AND PROCEDURES BEFORE OPERATION
5	GX Configurator-ST
6	PROGRAMMING
7	ONLINE MODULE CHANGE
8	COMMANDS

3.3.2 A/D conversion method

There are two conversion methods, sampling process and averaging process.

(1) Sampling process

The input analog value is converted to a digital value and the digital value is output.

Then, the output value is stored in $\boxed{Wr.n}$, $\boxed{Wr.n+1}$ CH□ digital output value.

Sampling processing time changes depending on the number of channels used (number of channels set to A/D conversion enable) and whether notch filter processing is performed or not.

(a) When notch filter processing is not performed

$$(\text{Processing time}) = (\text{Number of channels used}) \times 0.1 \text{ (ms/1channel)}$$

(b) When notch filter processing is performed

$$(\text{Processing time}) = (\text{Number of channels used}) \times 0.2 \text{ (ms/1channel)}$$

[Example] When notch filter processing is not performed and channels 1, 2 are used, sampling processing time is 0.2ms.

$$2 \times 0.1 = 0.2(\text{ms})$$

(2) Averaging process

The A/D conversion is performed for the specified channel as many times as the setting or for the set time. Then the sum of the values other than the maximum and minimum ones is averaged and the result is stored in $\boxed{Wr.n}$, $\boxed{Wr.n+1}$ CH□ digital output value.

The applicable setting ranges for the time and number of times are given below.

When the setting is outside the applicable range, the ERR. LED turns on and the A/D conversion of the corresponding channel stops.

- Averaging processing by time: 2 to 5000ms
- Averaging processing by the number of times: 4 to 62500

(a) When averaging process is set to be performed for the set time

The number of processing times within the set time changes depending on the number of channels used (number of channels set to A/D conversion enable) and whether notch filter processing is performed or not.

1) When notch filter processing is not performed

$$(\text{Number of processing repetitions}) = \frac{(\text{set time})}{(\text{Number of channels used}) \times 0.1 \text{ (ms/1channel)}}$$

2) When notch filter processing is performed

$$(\text{Number of processing repetitions}) = \frac{(\text{set time})}{(\text{Number of channels used}) \times 0.2 \text{ (ms/1channel)}}$$

[Example] When notch filter processing is performed, channels 1, 2 are used, and the set time is 55ms, measurement is made 137 times and an average value is output.

$$\frac{55}{2 \times 0.2} = 137.5(\text{times}) \dots \text{Round down the number}$$

(b) When the averaging process is set to be performed as many times as the setting
The result (average value) of averaging process that is performed as many times as the setting is stored in $\boxed{Wr.n}$, $\boxed{Wr.n+1}$ CH□ digital output value at certain intervals. The storage interval changes depending on the number of channels used (number of channels set to A/D conversion enable) and whether notch filter processing is performed or not.

1) When notch filter processing is not performed

(Processing time) = (Set number of times) × (Number of channels used) × 0.1
(ms/1channel)
(Unit:ms)

2) When notch filter processing is performed

(Processing time) = (Set number of times) × (Number of channels used) × 0.2
(ms/1channel)
(Unit:ms)

[Example] When notch filter processing is not performed, channels 1, 2 are used, and the set number of times is 500, the average value is output at 100ms intervals.

$500 \times 2 \times 0.1 = 100(\text{ms})$

3.3.3 Alarm output function

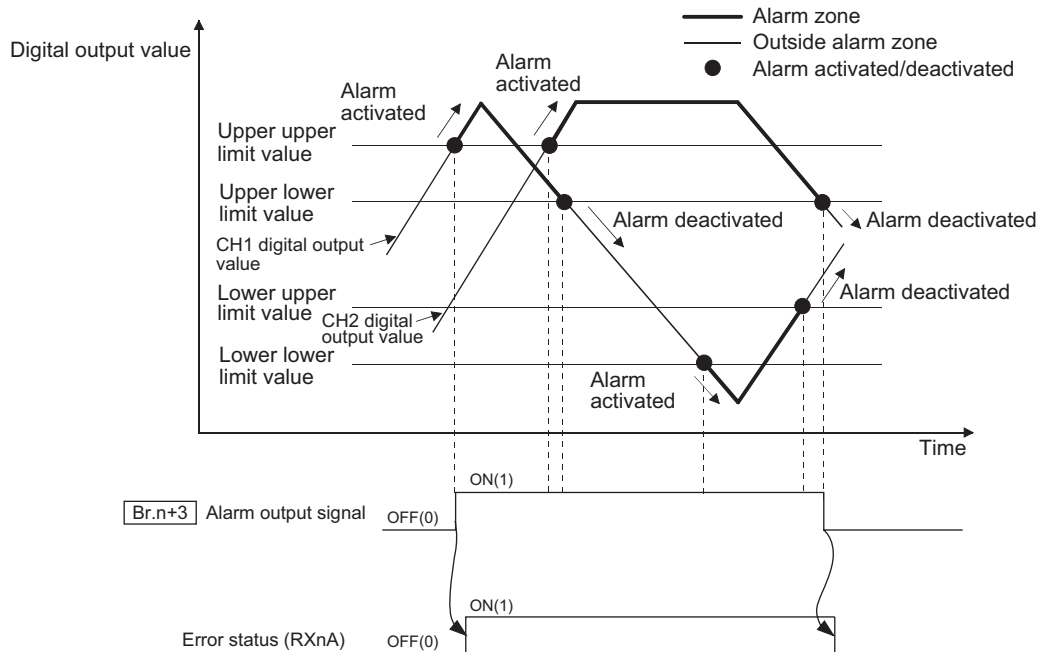

Figure 3.5 Alarm output function

- (1) If the detected digital value rises to or above the upper upper limit value or falls to or below the lower lower limit value and enters into the alarm output range, alarm output signal turns on (1) and Error status (RXnA) is set to ON.

Error status (RXnA) is a remote input of the head module.

For details of Error status (RXnA), refer to the following.

👉 MELSEC-ST CC-Link Head Module User's Manual, "3.3 Remote I/O, Remote Registers"

- (2) When the digital value falls below the upper lower limit value or rises above the lower upper limit value and all channel values have returned to within the setting range after the alarm output, alarm output signal automatically turns off (0).

Error status (RXnA) also turns off automatically. *1

* 1 If another error has occurred in the ST1AD, head module, or a slice module other than the ST1AD, Error status (RXnA) will not turn off.

- (3) Alarm output setting can be enabled/disabled for each channel.
Alarm output setting is set to "disabled" by default.

(4) Set the alarm output in 4 steps: upper upper limit value, upper lower limit value, lower upper limit value and lower lower limit value.

The setting range is -4096 to 4095 for the ST1AD2-V or -96 to 4095 for the ST1AD2-I, respectively.

If a set value is outside the above setting range or the condition of lower lower limit value \leq lower upper limit value \leq upper lower limit value \leq upper upper limit value is not satisfied, that channel will result in an error and the ERR. LED will turn on.

The upper upper limit value and upper lower limit value default to 4000.

The lower upper limit value and lower lower limit value default to -4000 for the ST1AD2-V, 0 for the ST1AD2-I, respectively.

(5) Alarm can be issued only for channel, whose A/D conversion is enabled.

3.3.4 Disconnection detection function

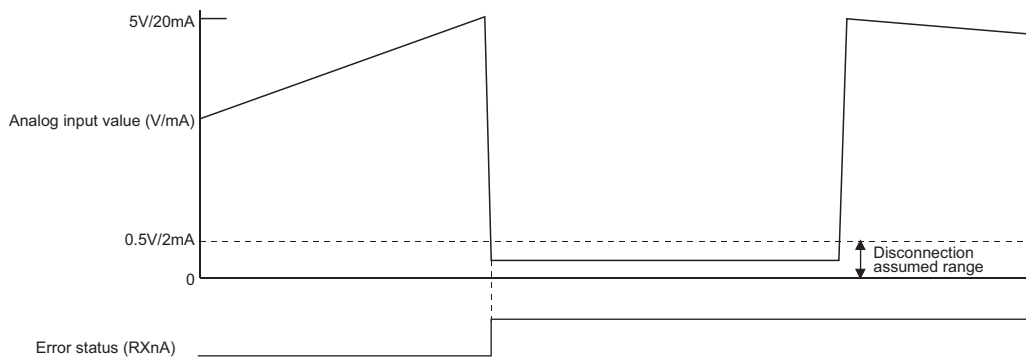

Figure 3.6 Disconnection detection function

(1) The disconnection detection function is usable in the range of 1 to 5V or 4 to 20mA only.

(2) If the analog input value falls to or below 0.5V in the 1 to 5V range, or to or below 2mA in the 4 to 20mA range, the ERR. LED turns on, Error status (RXnA) is set to ON, and an error code is stored.

Error status (RXnA) is a remote input of the head module.

For details of Error status (RXnA), refer to the following.

☞ MELSEC-ST CC-Link Head Module User's Manual, "3.4 Remote I/O, Remote Registers"

(3) Since Error status (RXnA) does not automatically turn OFF, use either of the following methods to clear the error.

(a) Error clear request command (command No.: 8104H/0104H)

Error status (RXnA) can be cleared using Error clear request command (command No.: 8104H/0104H) of the head module.

For details of Error clear request (command No.: 8104H/0104H), refer to the following.

☞ MELSEC-ST CC-Link Head Module User's Manual, "8.2.5 Error clear request (Command No.: 8104H/0104H)"

(b) Error reset request (RYnA)

Error status (RXnA) can be cleared using Error reset request (RYnA) of the head module.

For details of Error reset request (RYnA), refer to the following.

☞ MELSEC-ST CC-Link Head Module User's Manual, "3.4 Remote I/O, Remote Registers"

(4) Disconnection detection setting can be enabled/disabled for each channel.

Disconnection detection setting defaults to No disconnection detection processing performed on all channels.

(5) Disconnection can be detected only on channel, whose A/D conversion is enabled.

The accuracy of disconnection detection is the same as following.

(☞ Refer to Section 3.2.4 Accuracy)

(6) If a disconnection is detected during A/D conversion, the digital output value before the disconnection is held.

3.4 I/O Data

The ST1AD has the areas for data exchange with the head module as indicated below. This section explains the composition of each area.

Table 3.3 I/O data list

Transfer direction	Item	Number of Occupancy	Default value	Reference section
ST1AD → Head module (Input Data)	Br Bit Input Area	4	0	Section 3.4.1
	Wr Word Input Area	2	0	Section 3.4.2
Head module → ST1AD (Output Data)	Bw Bit Output Area	4	0	Section 3.4.3
	Ww Word Output Area	0	0	-

3.4.1 Bit input area

This section explains the $\boxed{\text{Br}}$ bit input area.

(1) "Br.n" Module ready

- (a) This turns on (1) when A/D conversion is ready after the MELSEC-ST system (ST1AD) is powered on or the head module is reset.
- (b) When the $\boxed{\text{Br.n}}$ Module ready signal is off (0), A/D conversion processing is not performed.

$\boxed{\text{Br.n}}$ Module ready turns off (0) in the following situations:

- In offset/gain setting mode
- When watchdog timer error occurred
- During online module change
☞ CHAPTER 7 ONLINE MODULE CHANGE

(2) "Br.n+1" Convert setting completed flag

- (a) After $\boxed{\text{Bw.n+1}}$ convert setting request has turned on (1), this turns on (1) when command parameter setting check is completed. (Turns on (1) if a setting error is detected.)

[When parameter setting check result is normal]

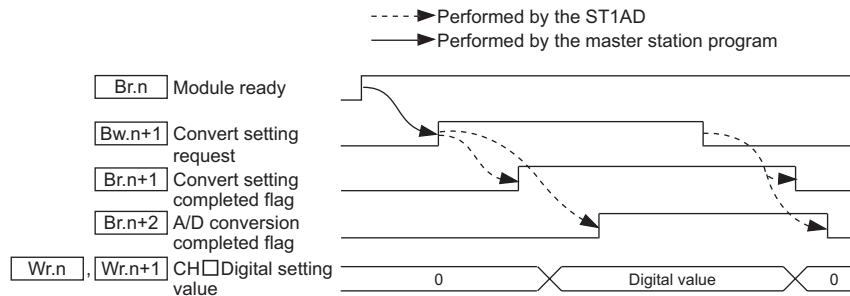

Figure 3.7 When parameter setting check result is normal

[When parameter setting check result is abnormal]

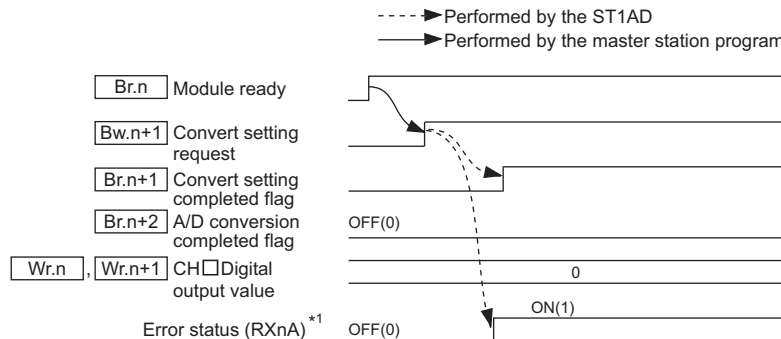

Figure 3.8 When parameter setting check result is abnormal

* 1 Error status (RXnA) is a remote input of the head module. For details of Error status (RXnA), refer to the following.

☞ MELSEC-ST CC-Link Head Module User's Manual, "3.4 Remote I/O, Remote Registers"

(3) "Br.n+2" A/D conversion completed flag

- (a) After Bw.n+1 convert setting request has turned on (1), Br.n+2 A/D conversion completed flag turns on (1) when A/D conversion is completed on all channels for which A/D conversion is enabled.
- (b) The Br.n+2 A/D conversion completed flag is processed only once when the Bw.n+1 convert setting request is changed.
- 1) When Bw.n+1 convert setting request is turned from off (0) to on (1)
When the digital value converted from an analog value is stored into Wr.n , Wr.n+1 CH□ digital output value, Br.n+2 A/D conversion completed flag turns on (1).
Specifying notch filter processing or averaging process will cause a delay in turning Br.n+2 A/D conversion completed flag on (1) by the processing time.
 - 2) When Bw.n+1 convert setting request is turned from on (1) to off (0)
 Br.n+2 A/D conversion completed flag turns off (0).

(4) "Br.n+3" Alarm output signal

- (a) This signal turns on (1) when the digital output value falls outside the setting range for the CH□ upper upper limit value/upper lower limit value and CH□ lower upper limit value/lower lower limit value on either channel where the alarm output is validated and A/D conversion is enabled.
- (b) This signal turns off (0) automatically when digital output values have returned to within the setting range on all channels for which enabled A/D conversion is enabled.

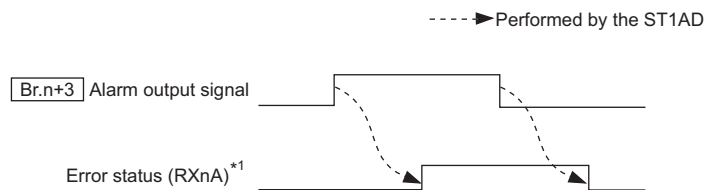
**Figure 3.9 Alarm output signal**

* 1 Error status (RXnA) is a remote input of the head module.
For details of Error status (RXnA), refer to the following.

☞ MELSEC-ST CC-Link Head Module User's Manual,
"3.4 Remote I/O, Remote Registers"

3.4.2 Word input area

This section explains the Wr word input area.

(1) "Wr.n" CH1 digital output value, "Wr.n+1" CH2 digital output value

- (a) The digital value converted from an analog value is stored into $Wr.n$, $Wr.n+1$ CH digital output value for each channel.
- (b) The digital value is stored in 16-bit, signed binary.

3.4.3 Bit output area

This section explains the Bw bit output area.

(1) "Bw.n" System area

Use of $Bw.n$ System area is prohibited. (Fixed to 0)

(2) "Bw.n+1" Convert setting request

- (a) Turn this on (1) to start A/D conversion of the channel for which A/D conversion is enabled. Setting this to off (0) stops the A/D conversion.
 - OFF (0): A/D conversion stop (Default)
 - ON (1): A/D conversion start
- (b) Turn this off (0) and then on (1) to enable the command parameter settings.
 - 1) When writing a command parameter, set $Bw.n+1$ convert setting request to off (0) to stop conversion. Data cannot be written when it is on (1).
 - 2) Regardless of whether $Bw.n+1$ convert setting request is on (1) or off (0), the input range setting is written although it does not take effect. (Set $Bw.n+1$ convert setting request to off (0) and then on (1).)
- (c) For the on (1)/off (0) timing, refer to the $Br.n+1$ column in Section 3.4.1.
 - OFF (0): A/D Conversion stop (Default)
 - ON (1): A/D Conversion start

(3) "Bw.n+2" System area, "Bw.n+3" System area

Use of $Bw.n+2$ and $Bw.n+3$ system areas is prohibited. (Fixed to 0.)

3.5 Memory and Parameters

This section explains the memory and parameters of the ST1AD.

3.5.1 Memory

RAM and ROM are available as the parameter storage memory of the ST1AD.

(1) RAM

- (a) The ST1AD operates based on the parameter settings stored in the RAM.
- (b) The parameter settings stored in the RAM become valid when the Bw.n+1 convert setting request turns from OFF to ON.

(2) ROM

- (a) The ROM stores the parameters. The stored parameters are not erased at power-off.
- (b) The parameters stored in the ROM are transferred to the RAM when:
 - The MELSEC-ST system (ST1AD) is powered off, then on.
 - The head module is reset.
 - Parameter setting read from ROM (command No.: B100H/3100H) is executed.

3.5.2 Parameters

The setting items required for operation of the ST1AD are called command parameters.

(1) Setting command parameters

Use either of the following methods to set command parameters.

(a) GX Configurator-ST

GX Configurator-ST allows easy on-screen setup, reducing programming steps on the master station.

The set values used at start of the MELSEC-ST system must be written to and stored in ROM. (RAM is used for writing data in the case of a temporary test.)

(b) Command

- 1) With the dedicated instruction (RDMSG) of the master station, set values are written to RAM of the ST1AD.
- 2) The set values in RAM are written to ROM, using Parameter setting write to ROM (command No.: B101H/3101H).
- 3) Writing command parameters to ROM in advance can reduce programming steps on the master station.

(2) Command parameter list

Command parameters and corresponding command numbers, which are used when using the dedicated instruction, are listed below.

These command parameters can be also set in GX Configurator-ST.

Table 3.4 List of available command parameters

Setting item	Command
Input range setting	8106H
	8107H/0107H
A/D conversion enable/disable setting	A100H/2100H
Averaging process specification, alarm output setting, disconnection detection setting	A102H/2102H
Notch filter setting	A103H/2103H
Time/count averaging setting	A104H/2104H
Upper upper/upper lower limit value setting	A108H/2108H
	A10AH/210AH
Lower upper/lower lower limit value	A109H/2109H
	A10BH/210BH

☒ POINT

For commands with the number 8000H and greater, determine the head module and slice modules with their slice position number.

And for commands with the number 7FFFH and lower, determine them with their start slice number.

CHAPTER4 SETUP AND PROCEDURES BEFORE OPERATION

4.1 Handling Precautions

- (1) Do not drop the module or give it hard impact since its case is made of resin.
Doing so can damage the module.
- (2) Do not disassemble or modify the modules.
Doing so could cause a failure, malfunction, injury or fire.
- (3) Be careful not to let foreign particles such as swarf or wire chips enter the module. They may cause a fire, mechanical failure or malfunction.

4.2 Setup and Procedure before Operation

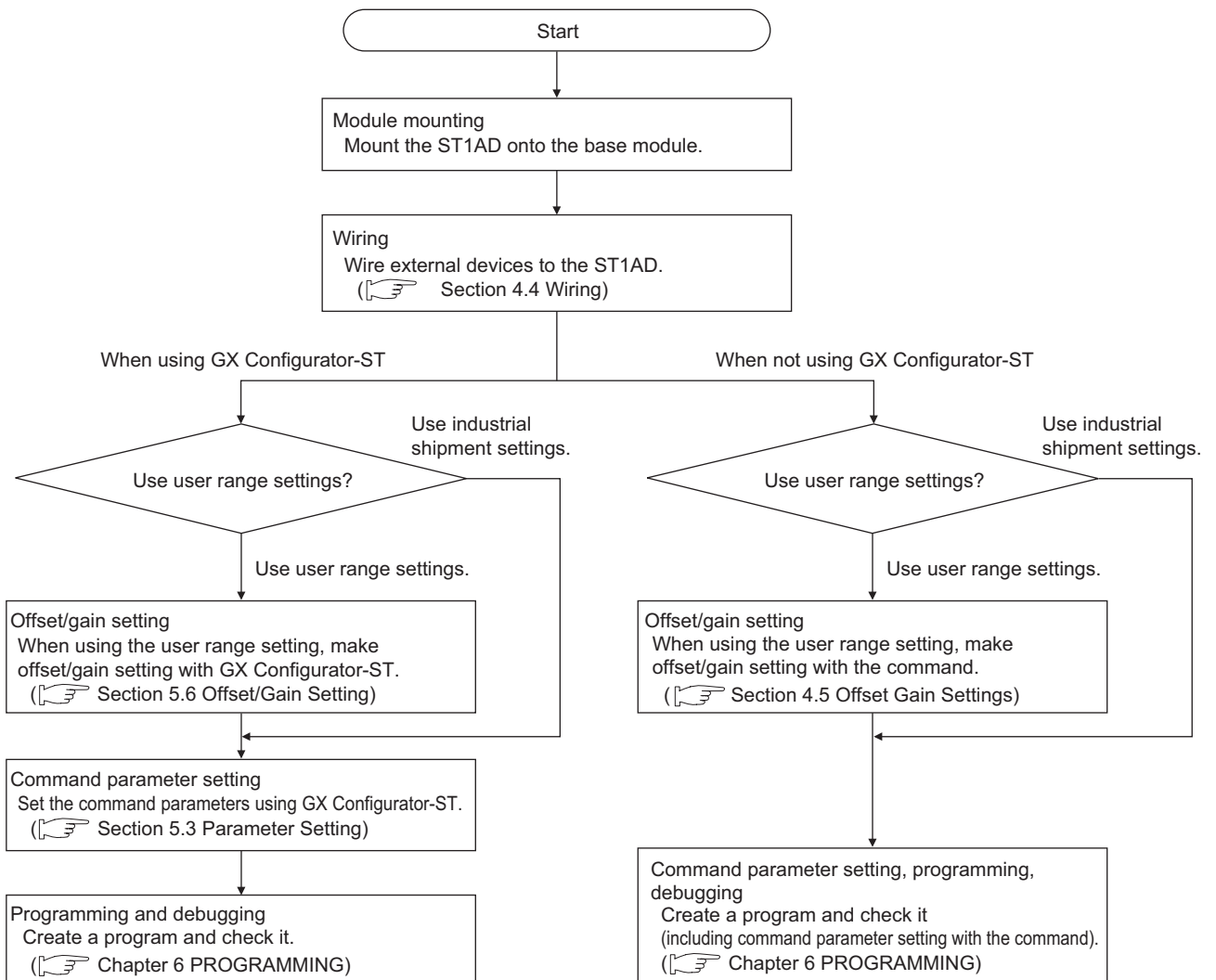

Figure 4.1 Setup and procedures before operation

4.3 Part Names

The name of each part in the ST1AD is listed below.

The following shows the ST1AD mounted on the spring clamp type base module.

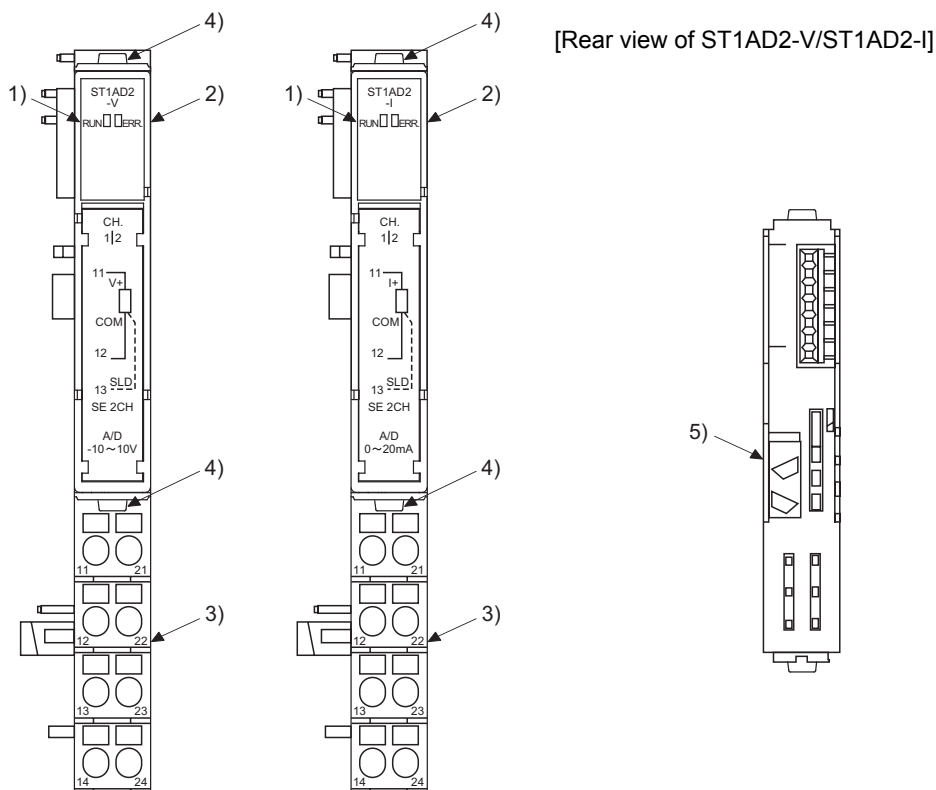

Figure 4.2 Part names

Table 4.1 Part names and functions

No.	Name and appearance	Description
1)	RUN LED	RUN LED and ERR. LED (on/flashing/off) indicate various statuses of the ST1AD (☞ Section 4.3.1 Status confirmation by LEDs).
2)	ERR. LED	
3)	Terminal block	The input signals of the ST1AD are wired to the terminal block of the base module. [Applicable base modules] Spring clamp type: ST1B-S4IR2 Screw clamp type: ST1B-E4IR2
4)	Slice module fixing hooks (at both ends)	Used for mounting/dismounting the ST1AD to/from the base module. While the hooks at both ends are pressed, mount/dismount the ST1AD.
5)	Coding element	Prevents the module from being mounted incorrectly. The coding element consists of two pieces, and its shape changes depending on the model name. When the ST1AD is mounted on the base module and then dismantled, one piece of the coding element remains on the base module, and the other remains on the ST1AD. The ST1AD can be mounted onto the base module that matches the ST1AD coding element. [Applicable coding element] ST1AD2-V: ST1A-CKY-13 ST1AD2-I: ST1A-CKY-14

POINT

In order to ensure safety, make sure to attach the coding element to the base module and ST1AD.

Table 4.2 Terminal number assignments

Terminal No.	Signal name			
	ST1AD2-V		ST1AD2-I	
11	CH1	V+	CH1	I+
12		COM		COM
13		SLD		SLD
14		Vacancy		Vacancy
21	CH2	V+	CH2	I+
22		COM		COM
23		SLD		SLD
24		Vacancy		Vacancy

4.3.1 Status confirmation by LEDs

The following table shows LED indications.

Table 4.3 LED indications

LED indication		Operating status
RUN LED	ERR.LED	
On	Off	Normal
	On	System error
Flashing (1s interval)	Off	Data communication stop or parameter error between master station and head module, another slice module fault, or internal bus error.
	On	System error occurred during data communication stop or a parameter error between master station and head module, or another slice module fault or internal bus error.
Flashing (0.5s interval)	Off	Module is in offset/gain setting mode
	On	System error occurred in offset/gain setting mode
Flashing (0.25s interval)	Off	Module is selected as the target of online module change
	On	System error occurred when module is selected as the target of online module change
Off	Off	Power is off or online module change is in execution.
	On	System error occurred during online module change

4.4 Wiring

The wiring precautions and examples of module connection are provided below.

4.4.1 Wiring precautions

In order to optimize the functions of the ST1AD and ensure system reliability, external wiring, that is protected from noise, is required.

Please observe the following precautions for external wiring:

- (1) Use separate cables for the AC control circuit and the external input signals of the ST1AD to avoid the influence of the AC side surges and inductions.**
- (2) Do not bring/install the cables closer to/together with the main circuit line, a high-voltage cable or a load cable from other than the MELSEC-ST system. This may increase the effects of noise, surges and induction.**
- (3) Ground the shield of the shielded wire or shielded cable at one point on the ST1AD side.**
Depending on noise conditions, however, it is recommended to ground the shield on the external device side.

4.4.2 External wiring

Wire the cables to the base module (sold separately).

(1) For the ST1AD2-V

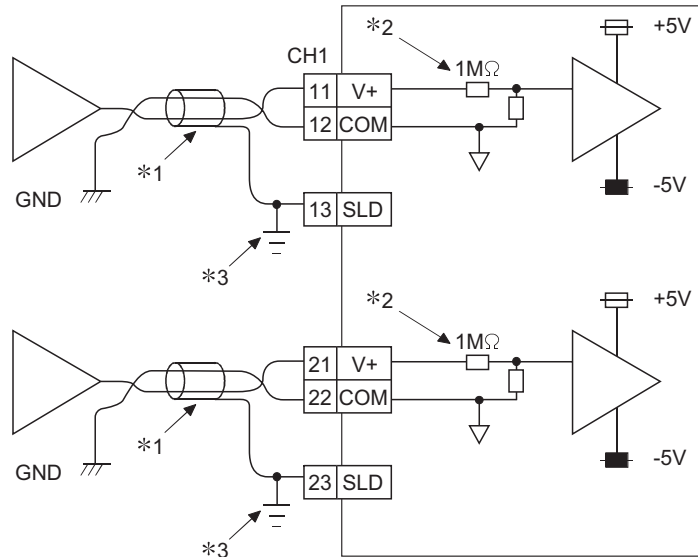

Figure 4.3 External wiring for the ST1AD2-V

- * 1 Use a twisted shielded pair cables.
- * 2 Shows input resistance of ST1AD2-V
- * 3 Connect the shield to the SLD terminal of base module, and then ground it using a cable clamp or terminal block.

The SLD terminal is not grounded to FG of power distribution module inside the module. Depending on noise conditions, however, it is recommended to ground the shield on the external device side.

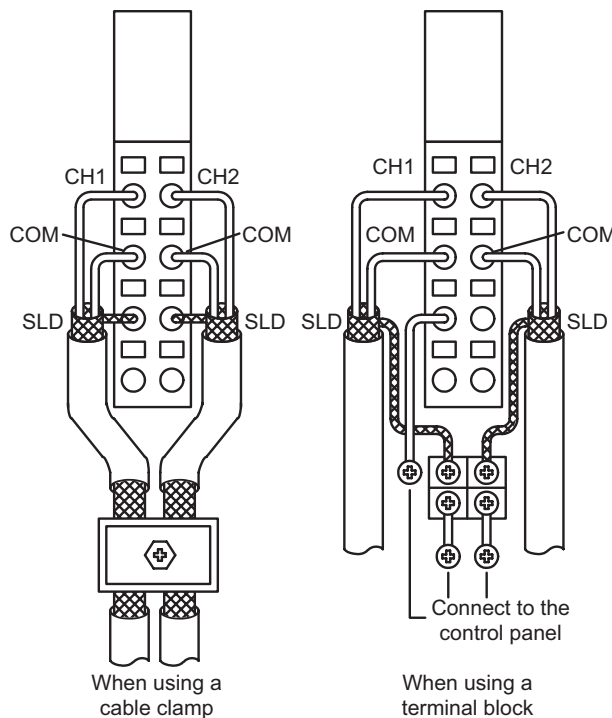

Figure 4.4 Terminal block wiring

(2) For the ST1AD2-I

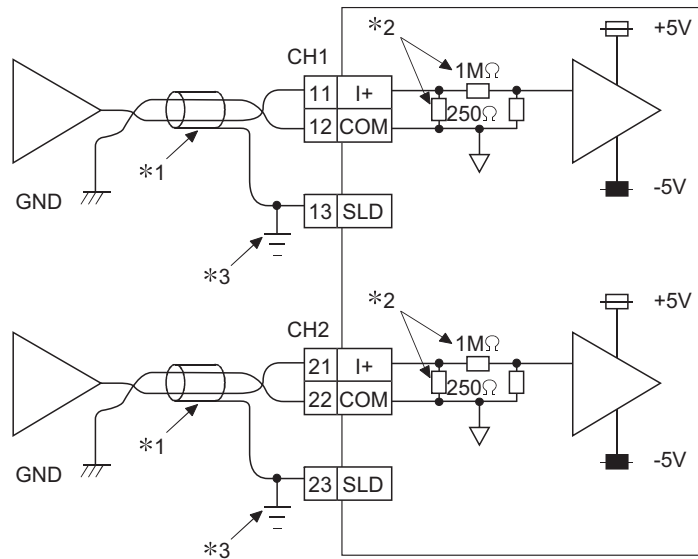

Figure 4.5 External wiring for the ST1AD2-I

- * 1 Use a twisted shielded pair cables.
- * 2 Shows input resistance of ST1AD2-I
- * 3 Connect the shield to the SLD terminal of base module, and then ground it using a cable clamp or terminal block.

The SLD terminal is not grounded to FG of power distribution module inside the module. Depending on noise conditions, however, it is recommended to ground the shield on the external device side.

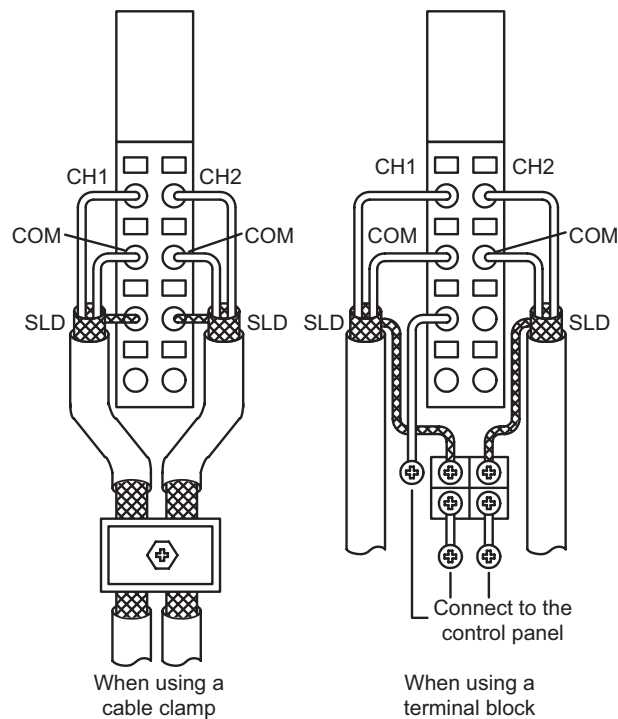

Figure 4.6 Terminal block wiring

POINT

The ST1AD needs to be powered on 5 minutes prior to operation for compliance to the specification (accuracy).

Therefore, power on 5 minutes prior to offset/gain setting or after online module replacement.

4.5 Offset/Gain Settings

To use the user range setting, configure the offset/gain settings.
When the factory default setting is used, offset/gain settings are not required.
Following methods for offset/gain settings are available.

(1) Setting offset/gain values with GX Configurator-ST

Configure offset/gain setting in GX Configurator-ST.

 Section 5.6 Offset/Gain Setting

(2) Setting offset/gain values using commands

Set offset/gain values as shown in Figure 4.7

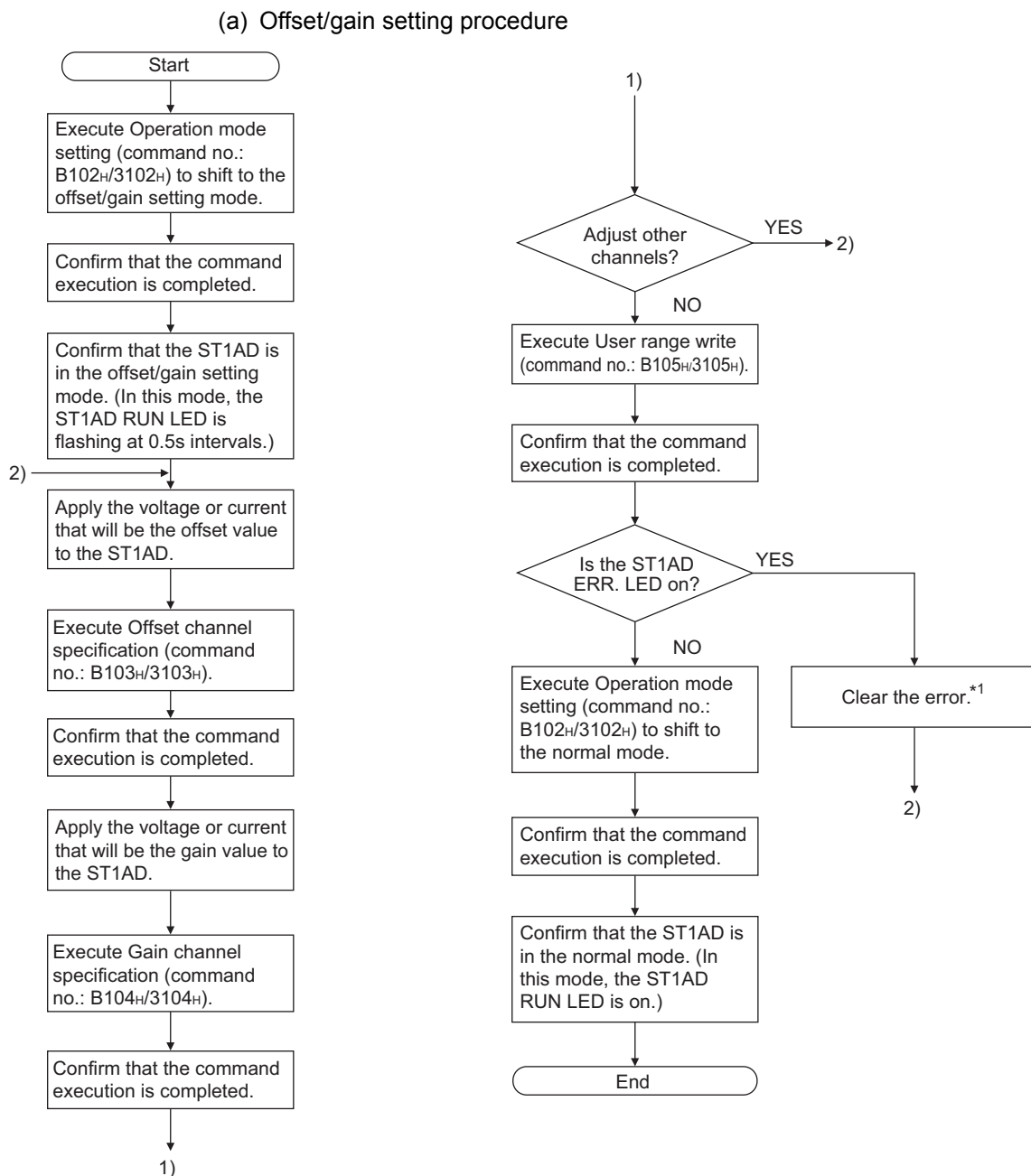

Figure 4.7 Offset/gain setting procedure

* 1 Error reset request (RYnA) is a remote output of the head module. For details of Error reset request (RYnA), refer to the following.

☞ MELSEC-ST CC-Link Head Module User's Manual "8.2.5 Error Reset Request".

☞ MELSEC-ST CC-Link Head Module User's Manual "3.4 Remote I/O, Remote Register".

☒ POINT

- (1) Make the offset/gain setting in the ranges that satisfy the conditions indicated in POINT (3) of Section 3.2.1 or POINT (3) of Section 3.2.2.
When the setting exceeds this range, the maximum resolution or total accuracy may not be within the range indicated in the performance specification.
 - (2) Set the offset/gain values according to the real application situation.
After the setting is completed, confirm that the offset/gain values are set correctly in the real application.
 - (3) The offset and gain values are stored into the ROM and are not erased at power-off.
 - (4) When making the offset/gain setting, write the values to the ROM using User range write (command No. : B105H/3105H).
Data can be written to the ROM up to 10,000 times.
To prevent accidental write to the ROM, write to ROM is counted, starting at power-on.
 - (5) If an error occurs during offset/gain setting, the offset and gain values are not written to the ST1AD.
Set the correct offset and gain values again.
-

(3) Programming

The program example given here contains mode switching (between normal mode and offset/gain setting mode), specification of the offset/gain setting channel, offset/gain value adjustment, and offset/gain value writing to the ST1AD.

(a) Device allocation in the program example

For devices used in common with other program examples, refer to the following.

 Section 6.4 Program Examples

1) Device allocation in the program example**Table 4.4 Setting for initial data write command**

Device	Application	Device	Application
M1000	Other station data link status (Station No.1)	D1000 to D1004	Control data
M1001	Other station data link status (Station No.2)	D1100 to D1104	Send data (execution data of the command)
M1002	Data link status of ST1H-BT (Station No.3)	D1300 to D1304	Receive data (result data of the command)
M2000	Completion device	-	-
M2001	Completion status indicator device		
M3000	Offset/gain setting mode switching flag		
M3001	Offset channel specification flag		
M3002	Gain channel specification flag		
M3003	User range write flag		
M1004	Normal mode switching flag		
M4000	Error reset request flag		

2) Program example

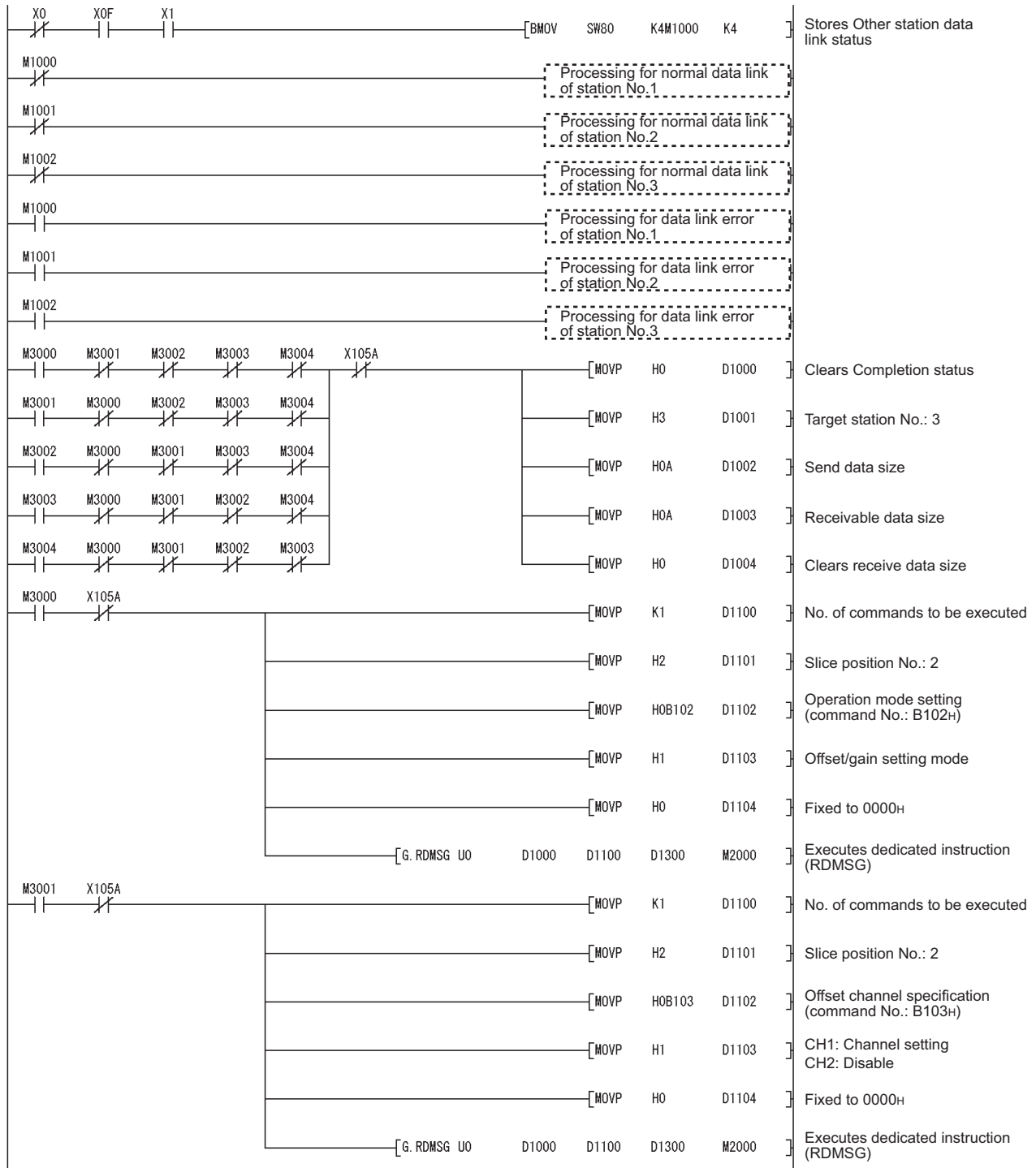

4 SETUP AND PROCEDURES BEFORE OPERATION

MELSEC-ST

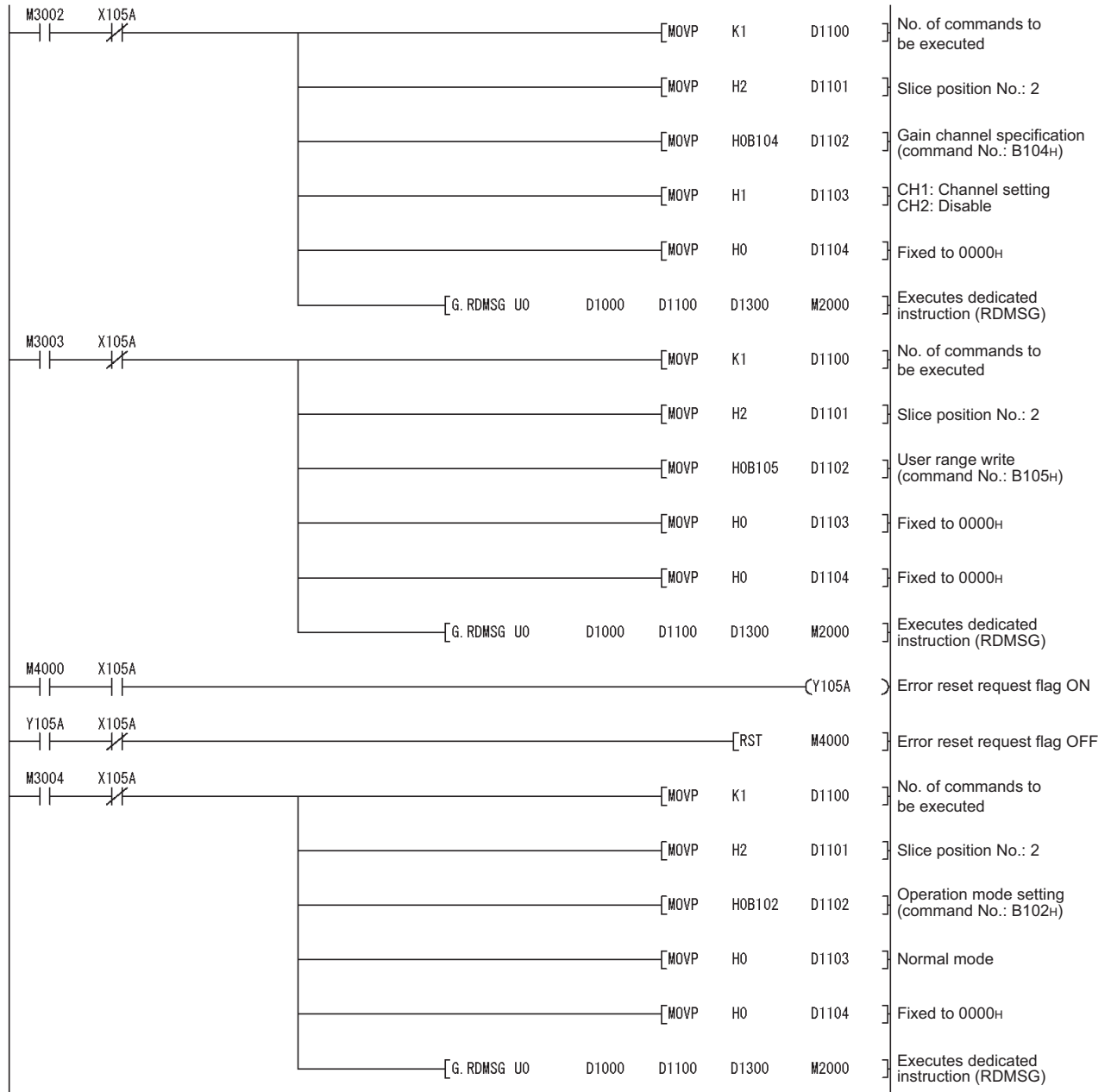

1

OVERVIEW

2

SYSTEM CONFIGURATION

3

SPECIFICATIONS

4

SETUP AND PROCEDURES BEFORE OPERATION

5

GX Configurator-ST

6

PROGRAMMING

7

ONLINE MODULE CHANGE

8

COMMANDS

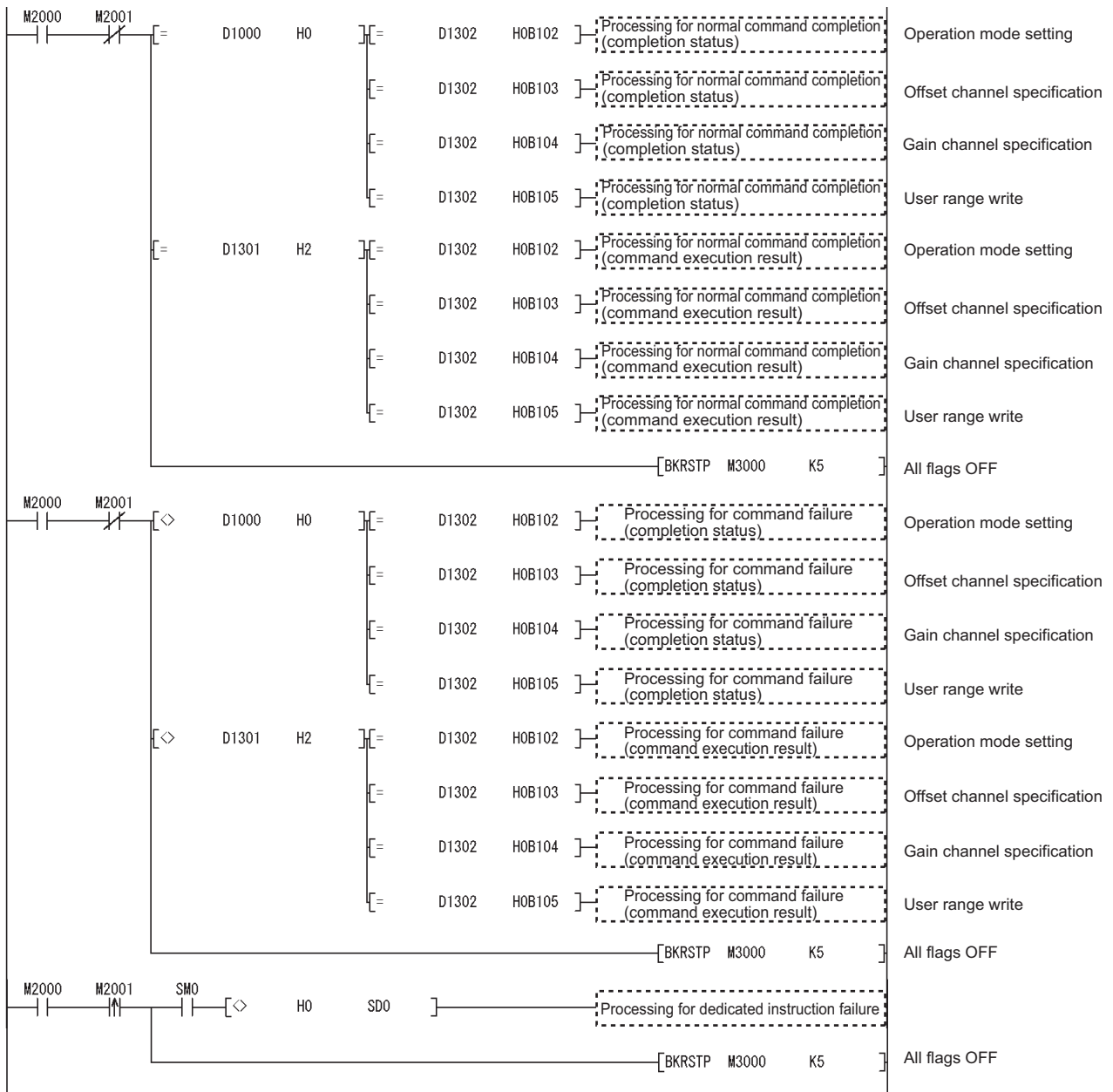

CHAPTER5 GX Configurator-ST

This chapter explains the functions of GX Configurator-ST used with the ST1AD. For details of GX Configurator-ST, refer to the following.

 GX Configurator-ST Operating Manual

5.1 GX Configurator-ST Functions

Table 5.1 lists the GX Configurator-ST functions used with the ST1AD.

Table 5.1 List of GX Configurator-ST functions used with ST1AD

Item	Description	Reference section
Parameter Setting	<p>(1) The following parameter items can be set on GX Configurator-ST.</p> <ul style="list-style-type: none"> •CH□ input range setting •CH□ time/number of times specification •CH□ sampling process/averaging process setting •CH□ alarm output setting •CH□ disconnection detection setting •CH□ A/D conversion enable/disable setting •50/60Hz notch filter specification •CH□ average time/average number of times setting •CH□ upper upper limit value/upper lower limit value/lower upper limit value/lower lower limit value <p>(2) Specify the area (RAM or ROM) where parameter setting will be registered.</p> <p>(3) Using GX Configurator-ST, parameter setting can be made while online module change is performed.</p>	Section 5.3
Input/output monitor	(1) The I/O data of the ST1AD can be monitored.	Section 5.4
Forced output test	(1) Test can be conducted with the values set in the <input type="checkbox"/> Bw bit output area of the ST1AD.	Section 5.5
Offset/gain setting	<p>(1) The offset and gain values of the user range can be easily set on-screen.</p> <p>(2) Using GX Configurator-ST, gain/offset setting can be made while online module change is performed.</p>	Section 5.6
Online module change	(1) A module can be replaced without stopping the system.	CHAPTER 7

5.2 Creating a project

(1) Creating a project

A new project can be created by reading the real MELSEC-ST system from the communication port and by creating it offline if there is no MELSEC-ST system. For more details about creating a project, refer to the following.

 GX Configurator-ST Operating Manual

(2) Selecting a head module

To create a project offline, "CC-Link (ST1H-BT)" must be selected in the next screen, and then click the button.

(3) Display/setting screen

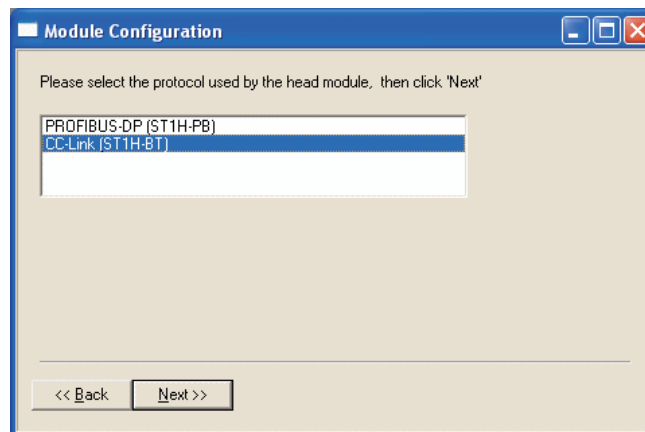

Figure 5.1 Selecting a head module

5.3 Parameter Setting

This section explains how to set the parameters.

If the parameters are set with GX-Configurator ST, the programs used to set the parameters is not required anymore.

If these parameters should be used everytime when the MELSEC-ST system starts up, these must be written to the ROM.

(Writing the parameters to the RAM is used only for temporary testing)

(1) Mode changing

The mode need not be changed.

Parameter setting is available in both edit and diagnosis modes.

(2) "Parameter Setting" screen display

(a) Select ST1AD on the "Module Configuration" or "System Monitor" screen.

(b) Click [Edit] → [Parameter Setting].

(3) Display/setting screen

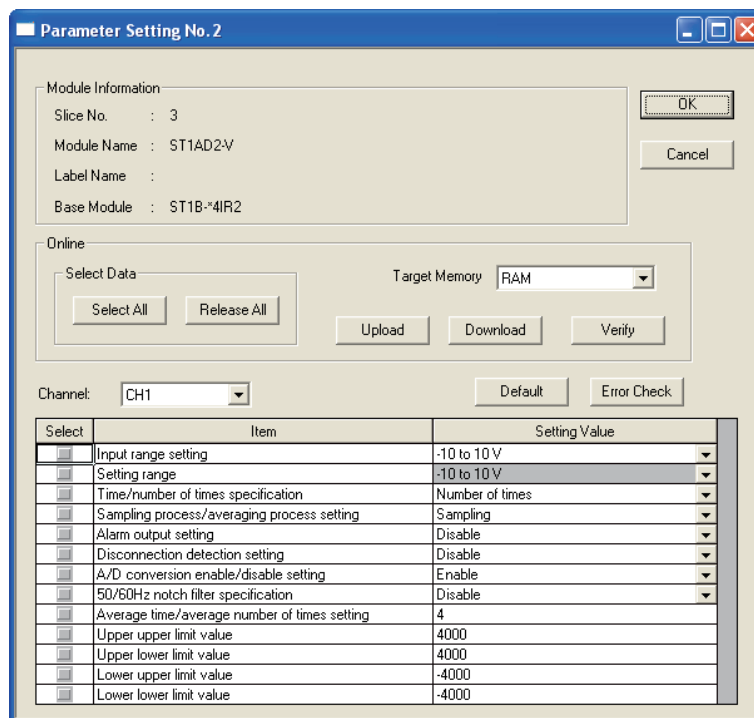

Figure 5.2 Parameter setting screen

(4) Display/setting details

The parameters listed below can be set for each channel. If you need to set these parameter in all channels, you have to set it separately for each channel.

- (a) Input range setting
Set the input range.
Select an input range from the following options.

Table 5.2 Input range

Model	Input range
ST1AD2-V	-10 to 10V
	0 to 10V
	0 to 5V
	1 to 5V
	User range setting
ST1AD2-I	4 to 20mA
	0 to 20mA
	User range setting

- (b) Setting range
The actual input range setting used in the ST1AD is showed here, and cannot be changed here.
- (c) Time/number of times specification
Specify time or number of times when the averaging processing is selected.
- (d) Sampling process/averaging process setting
Specify sampling processing or averaging processing.
- (e) Alarm output setting
Set whether to enable the alarm output or not.
Disable: Alarm output not performed
Enable: Alarm output performed
- (f) Disconnection detection setting
Set whether to enable the disconnection detection or not.
Disable: Disconnection detection not performed
Enable: Disconnection detection performed
- (g) A/D conversion enable/disable setting
Set whether to enable or disable the A/D conversion.
Disable: A/D conversion enabled
Enable: A/D conversion disabled
- (h) 50/60Hz notch filter specification
Set the notch filter processing.
Notch filter processing must be set to channel 1 for all channels.
Disable: No notch filter processing for all channels
Enable (50Hz): Notch filter processing for all channels ($50 \pm 3\text{Hz}$)
Enable (60Hz): Notch filter processing for all channels ($60 \pm 3\text{Hz}$)
- (i) Average time/average number of times setting
Set the time or number of times used for averaging.
The setting ranges are as follows:
Average number of times: 4 to 62500 times
Average time: 2 to 5000ms

- (j) Upper upper limit value/Upper lower limit value/Lower upper limit value/Lower lower limit value

Set the upper upper limit value, upper lower limit value, lower upper limit value and lower lower limit value of the alarm output.

The setting range of the ST1AD2-V is -4096 to 4095.

The setting range of the ST1AD2-I is -96 to 4095.

(5) Parameter writing operation

- 1) In Input/Output Monitor of GX Configurator-ST, check that Bw.n+1 convert setting request is OFF (0). (☞ Section 5.4 Input/Output Monitor(2))
- 2) From the "Channel:" pull-down menu, select a channel for parameter setting.
- 3) Select parameter items to be written to the ST1AD by checking the corresponding "Select" check boxes.
- 4) Setting values in the "Setting Value" fields.
- 5) Select the target memory (RAM or ROM) from the pull-down menu of "Target Memory".
- 6) Click the button.

When writing the parameters of multiple channels to the ST1AD, perform the steps 2) to 6) for each channel.

POINT

Before writing parameters, make sure that Bw.n+1 convert setting request is OFF (0).

If Bw.n+1 convert setting request is ON (1), parameters cannot be written.

5.4 Input/Output Monitor

This section explains how to monitor the I/O data of the ST1AD.

(1) Mode changing

Click [Mode] → [Diagnosis]

(2) "Input/Output Monitor" screen display

- 1) Select ST1AD on the "System Monitor" screen.
- 2) Click the button.

Monitoring starts as soon as the "Input/Output Monitor" screen is displayed.

(3) Display/setting screen

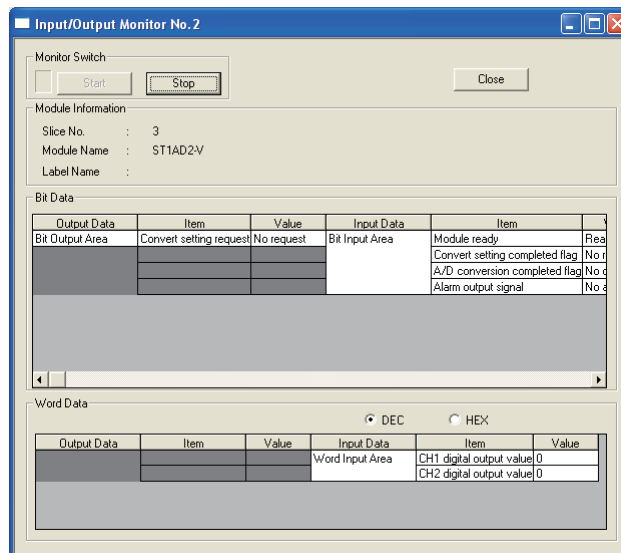

Figure 5.3 I/O data

(4) Display/setting details

(a) Bit Data

Table 5.3 Bit Data list

Input/Output Data	Item	Description
Bit Output Area	Convert setting request	The status of <input type="text" value="Bw.n+1"/> convert setting request is displayed.
Bit Input Area	Module ready	The status of <input type="text" value="Br.n"/> module ready is displayed.
	Convert setting completed flag	The status of <input type="text" value="Br.n+1"/> convert setting completed flag is displayed.
	A/D conversion completed flag	The status of <input type="text" value="Br.n+2"/> A/D conversion completed flag is displayed.
	Alarm output signal	The status of <input type="text" value="Br.n+3"/> alarm output signal is displayed.

(b) Word Data

The display format (decimal/hexadecimal) can be changed.

Table 5.4 Word Data list

Input/Output Data	Item	Description
Word Input Area	CH□ digital output value	The values of <input type="text" value="Wr.n"/> and <input type="text" value="Wr.n+1"/> CH□ digital output values are displayed.

5.5 Forced Output Test

This section explains a forced output test.
Conduct the test after setting values to the bit output area of the ST1AD.

(1) Mode changing

Click [Mode] → [Diagnosis]

(2) "Forced Output Test" screen display

- 1) Select ST1AD on the "System Monitor" screen.
- 2) Click the button.

(3) Display/setting screen

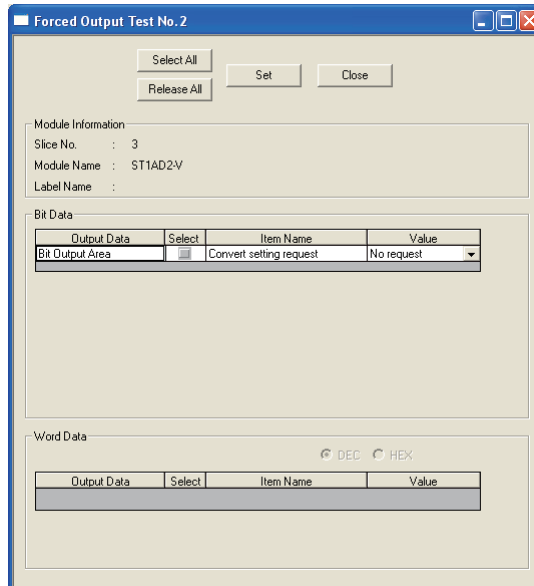

Figure 5.4 Forced output test screen

(4) Display/setting details

(a) Bit Data

Table 5.5 Bit Data list

Output Data	Item	Description
Bit Output Area	Convert setting request	The setting of <input type="text" value="Bw.n+1"/> convert setting request can be changed.

(b) Word Data

Unavailable for the ST1AD.

(5) Test operation

- (a) Select the test item by checking the corresponding "Select" check box.
- (b) Make setting in the "Value" field.
- (c) Click the button.*¹

Clicking the button executes the test.

* 1 When the module is not in the forced output test mode, a screen appears asking whether to switch to the forced output test mode. Click the button to switch to the forced output test mode. When the forced output test mode is activated, the RUN LED of the head module flashes.

POINT

When having exited the forced output test mode, make sure that the RUN LED of the head module is on.

5.6 Offset/Gain Setting

This section explains how to make offset/gain setting.

(1) Mode changing

Click [Mode] → [Diagnosis]

(2) "Offset/Gain Setting" screen display

1) Select ST1AD on the "System Monitor" screen.

2) Click the button.*¹

* 1 When the module is not in the forced output test mode, a screen appears asking whether to switch to the forced output test mode. Click the button to switch to the forced output test mode. When the forced output test mode is activated, the RUN LED of the head module flashes.

3) As a screen appears asking whether to switch to the offset/gain setting mode, click the button to switch to the offset/gain setting mode.

After switched to the offset/gain setting mode, the RUN LED of ST1AD flashes (0.5s interval) and the ST1AD stops.

(3) Display/setting screen

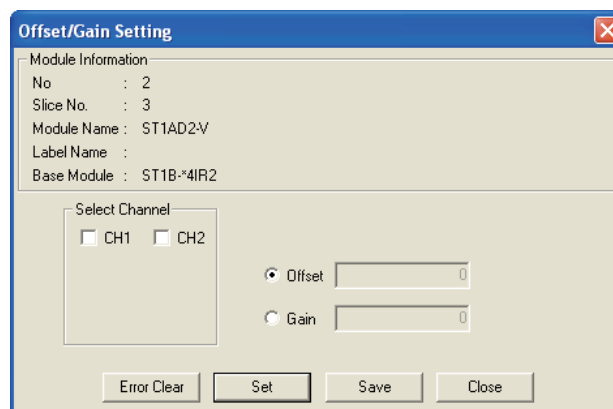

Figure 5.5 Offset/gain setting screen

(4) Offset/gain setting operation

When setting different offset and gain values for different channels, perform the operations in (a), (b) for each channel.

Perform the operation in (c) only once at the last since it writes the offset/gain settings of all channels to the ST1AD.

(a) Offset value setting operation

- 1) Select a channel by checking the corresponding "Select channel" check box. By checking multiple check boxes, values can be set to multiple channels at the same time.
- 2) Specify "Offset".
- 3) Set the voltage or current as an offset value, and click the button.

(b) Gain value setting operation

- 1) Select a channel by checking the corresponding "Select channel" check box. By checking multiple check boxes, values can be set to multiple channels at the same time.
- 2) Specify "Gain".
- 3) Set the voltage or current as an gain value, and click the button.

(c) Offset/gain setting writing operation

Click the button.

The offset/gain settings of all channels are written to the ST1AD.

☒ POINT

- (1) An error occurs if the button is clicked when the offset value is equal to/greater than the gain value.
In this case, click the button to clear the error, and make setting again.
- (2) When the offset/gain setting screen is closed, the screen displays a message that asks if you are sure to change to the normal mode. Click the button to change to the normal mode.
When the module enters the normal mode, the RUN LED of the ST1AD turns on.
- (3) When having exited the forced output test mode, make sure that the RUN LED of the head module is on.

CHAPTER6 PROGRAMMING

This chapter describes example programs available when the QJ61BT11N is used as a master station.

Remark

For details of the QJ61BT11N, refer to the following manual.

 CC-Link System Master/Local module User's Manual

.....

6.1 Programming Procedure

The following procedure describes how to create a project that will execute A/D conversion of ST1AD.

When applying any of the program examples introduced in this chapter to the actual system, verify the applicability and confirm that no problems will occur in the system control.

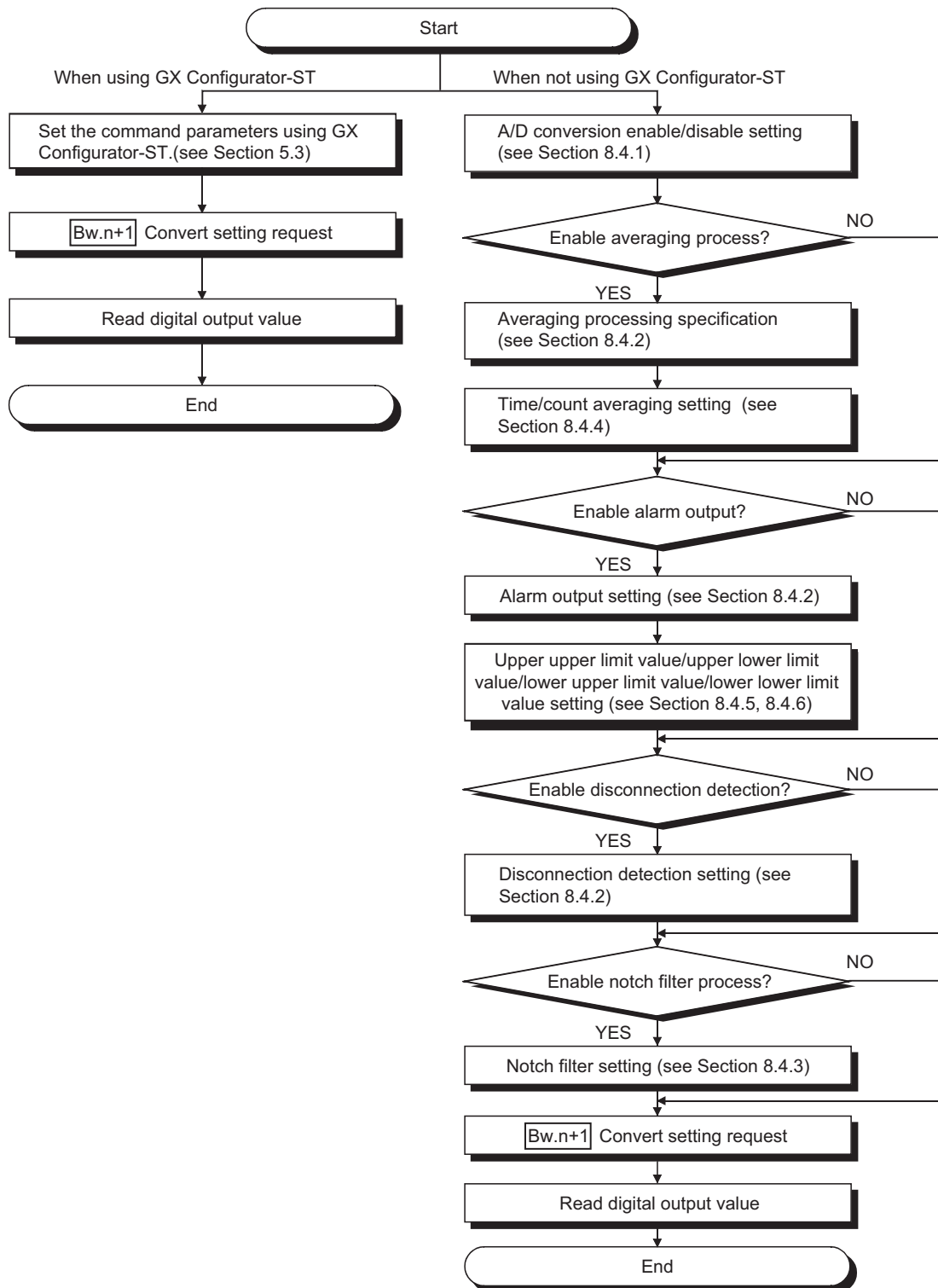

Figure 6.1 Programming procedure

POINT

- (1) With one dedicated instruction (RDMSG), up to eight commands can be simultaneously executed.

However, the following commands cannot be executed with any other command at the same time.

Initial data batch write request (command No.: 8106H)

Initial data individual write request (command No.: 8107H/0107H)

If executed simultaneously, an error will occur.

- (2) The sizes of **Cw** Command execution area and **Cr** Command result area vary depending on the command.
- (3) In the following cases, commands cannot be executed. Therefore, execute the command after following cases finished.
- The head module is executing the self-diagnostics function.
 - A slice module is being replaced online.
 - Another command is in execution. (The dedicated instruction (RDMSG) is not completed.)
- (4) For online module change, advance preparation may be required depending on the operating conditions. For details, refer to the following.

 Section 7.2 Preparations for Online Module Change

6.2 System Configuration Example

The following system example is used for the programs described in this chapter.

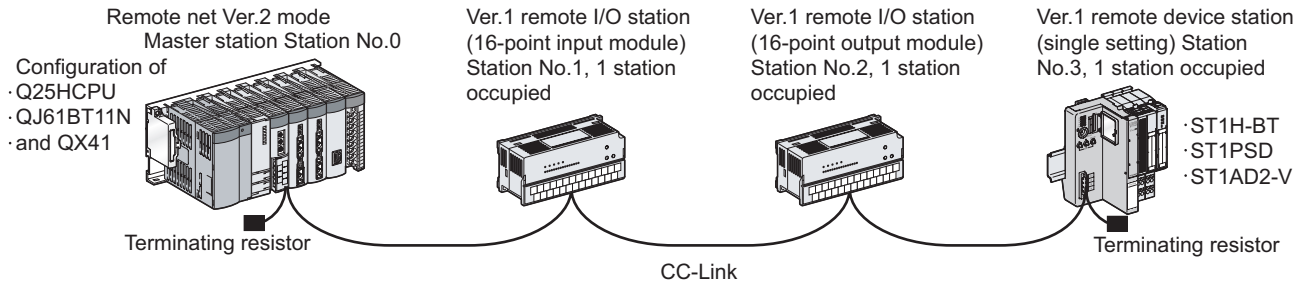

Figure 6.2 System configuration example

(1) System configuration of master station

Table 6.1 System configuration of master station

Module	Input signal	Output signal
Q25HCPU	-	-
QJ61BT11N	X00 to X1F	Y00 to 1F
QX41	X20 to X3F	-

(2) MELSEC-ST system configuration

Table 6.2 I/O points sheet

Slice position No.	Start slice No. (No. of occupied slices)	Module name	Br.n	Bw.n	Wr.n	Ww.n	5V DC internal current consumption (Total)	24V DC current (Total)	Slot width (Total)
	0(2)	ST1H-BT	0	0	0	0	0.410A(0.410A)	0A(0A)	-
	2(1)	ST1PSD	0	0	0	0	-	-	25.2mm (25.2mm)
	3(2)	ST1AD2-V	4	4	2	0	0.110A(0.520A)	*1	12.6mm (37.8mm)
Total			4	4	2	0	-	-	37.8mm (850mm or more)
			(252 bits or less)*2	(252 bits or less)*2	(52 words or less)	(52 words or less)			

* 1 The 24V DC current varies depending on the external device connected to each slice module. Check the current consumption of external devices connected to slice modules, and calculate the total value. (MELSEC-ST System User's Manual)

* 2 The number of available points reduces by two points for each additional power distribution module.

6.3 Settings and Communication Data

After determining the system configuration, set parameters of the programmable controller CPU of the master station.

(1) Setting PLC parameters (I/O assignment)

Connect GX Developer to the programmable controller CPU of the master station, and set PLC parameters as shown below.

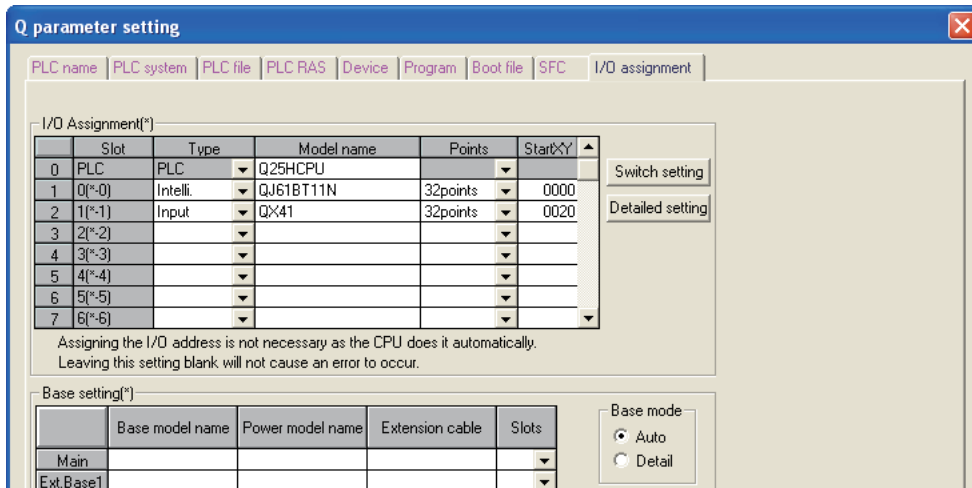

Figure 6.3 I/O assignment

(2) Network parameters

Connect GX Developer to the programmable controller CPU of the master station, and set network parameters as shown below.

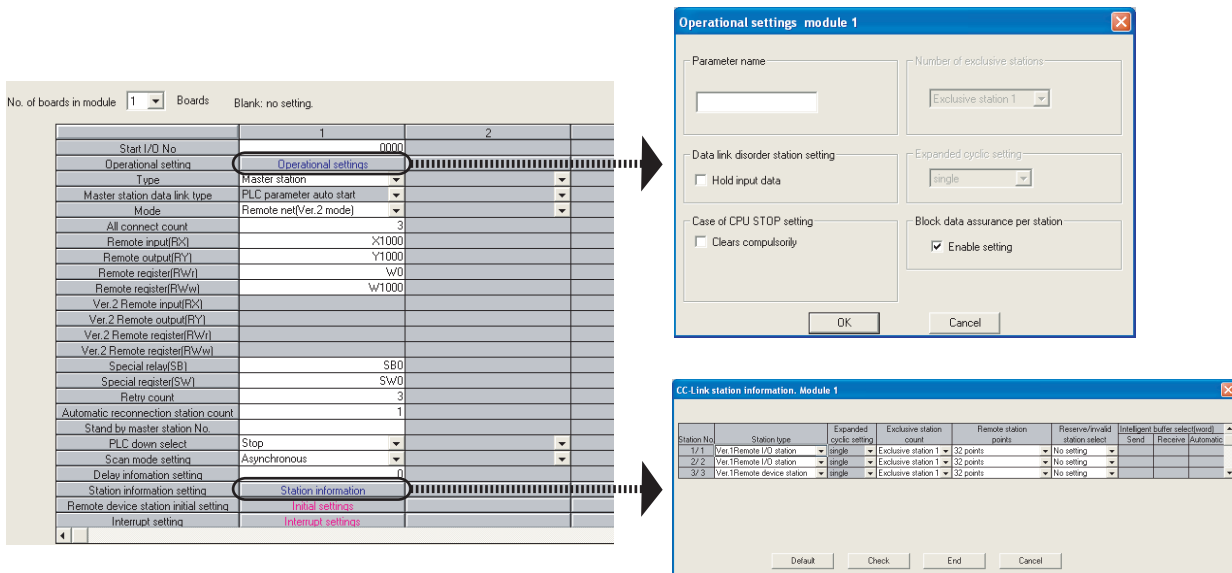

Figure 6.4 Setting network parameters

(3) I/O data assignment

The following are I/O data assignment results for the system configuration example in this chapter.

The I/O points sheet is useful for I/O data assignment.

For details of the I/O data assignment sheet, refer to the following.

☞ MELSEC-ST CC-Link Head Module User's Manual, "Appendix 3.2 Input data assignment sheet, Appendix 3.3 Output data assignment sheet"

(a) "Br" Bit input area (Remote input (RX))

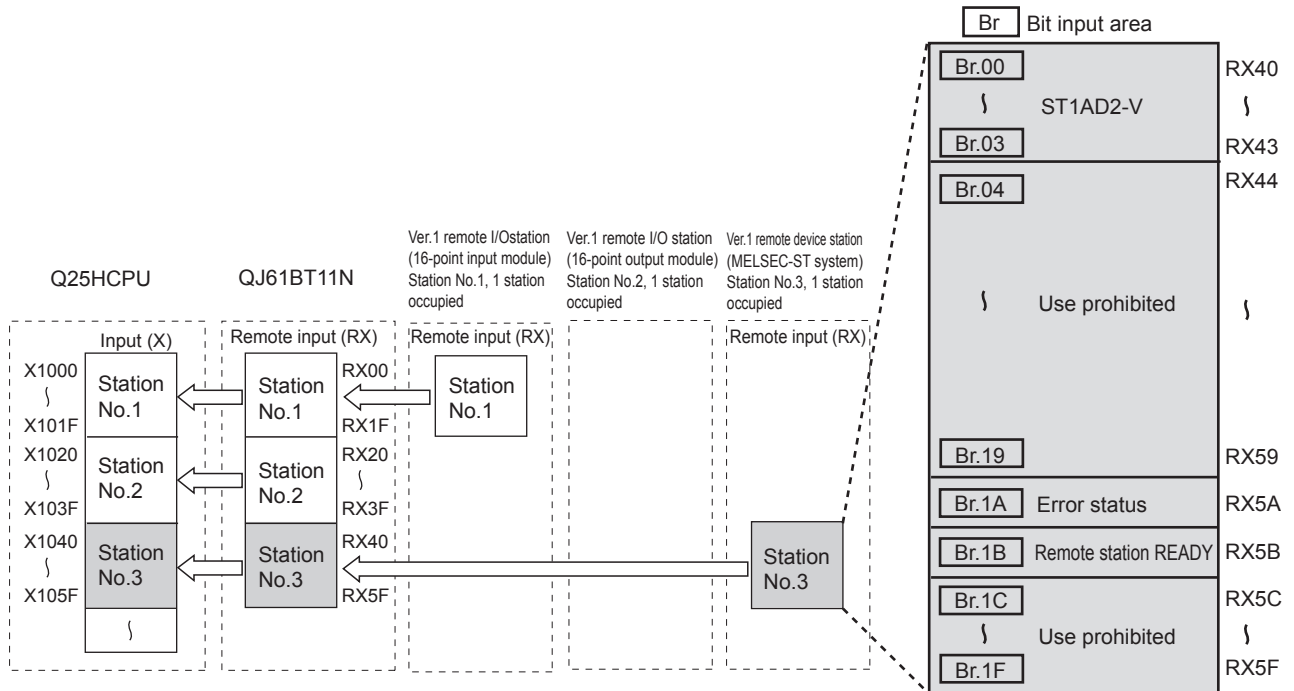

Figure 6.5 "Br" Bit input area (remote input (RX))

Table 6.3 "Br" Bit input area assignment sheet

Master station		Remote device station (MELSEC-ST system)			
Device	Remote input (RX)	Slice position No.	Module name	Br.n	Data name
X1040	RX40	2	ST1AD2-V	Br.00	Module READY
X1041	RX41			Br.01	Convert setting completion flag
X1042	RX42			Br.02	A/D conversion complete flag
X1043	RX43			Br.03	Alarm output signal
X1044	RX44			Br.04	Use prohibited
to		to			
X1059	RX59	-	-	Br.19	Use prohibited
X105A	RX5A	-	-	Br.1A	Error status *1
X105B	RX5B	-	-	Br.1B	Remote station READY *1
X105C	RX5C	-	-	Br.1C	Use prohibited
to		to			
X105F	RX5F	-	-	Br.1F	Use prohibited

* 1 Error status (RXnA) and Remote station READY (RXnB) are remote input areas of the head module. For details of remote input, refer to the following.

☞ MELSEC-ST CC-Link Head Module User's Manual, "3.4 Remote I/O, Remote Registers"

(b) "Bw" Bit output area (Remote output (RY))

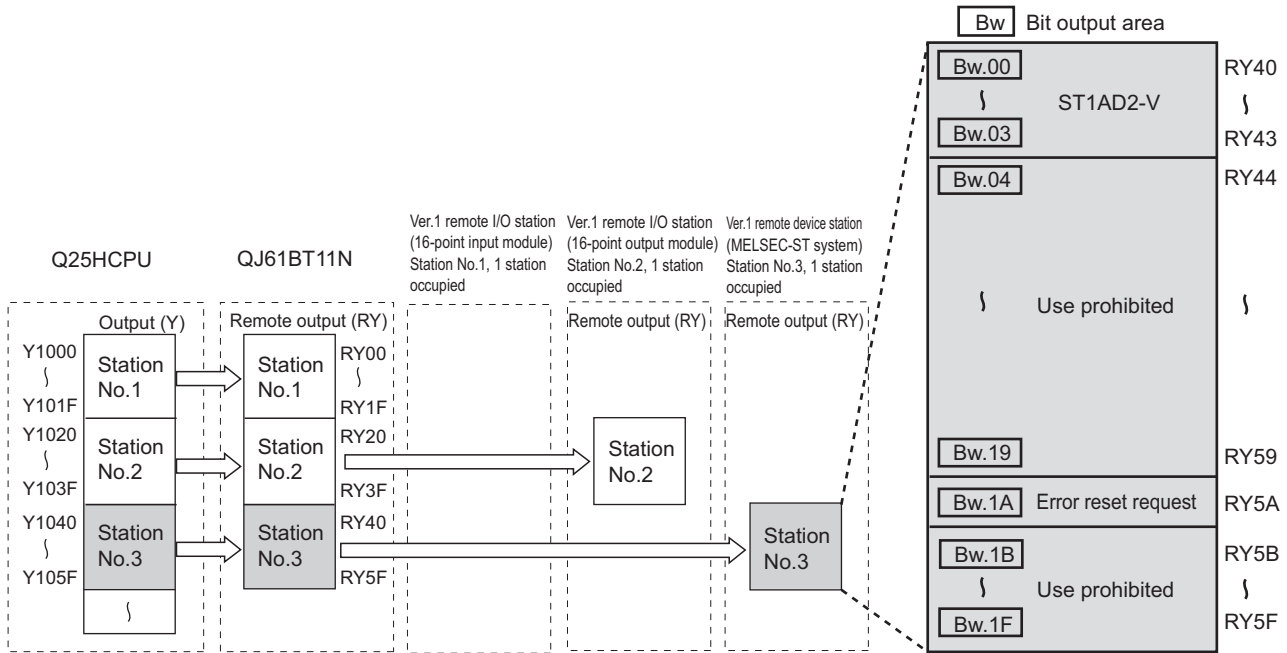

Figure 6.6 "Bw" Bit output area (Remote output (RY))

Table 6.4 "Bw" Bit output area assignment sheet

Master station		Remote device station (MELSEC-ST system)			
Device	Remote output (RY)	Slice position No.	Module name	Bw.n	Data name
Y1040	RY40	2	ST1AD2-V	Bw.00	Use prohibited
Y1041	RY41			Bw.01	Convert setting request
Y1042	RY42			Bw.02	Use prohibited
Y1043	RY43			Bw.03	Use prohibited
Y1044	RY44	-	-	Bw.04	Use prohibited
to		to			
Y1059	RY59	-	-	Bw.19	Use prohibited
Y105A	RY5A	-	-	Bw.1A	Error reset request *1
Y105B	RY5B	-	-	Bw.1B	Use prohibited
to		to			
Y105F	RY5F	-	-	Bw.1F	Use prohibited

* 1 Error reset request (RYnA) is a remote output area of the head module.
For details of Error reset request (RYnA), refer to the following.

➡ MELSEC-ST CC-Link Head Module User's Manual, "3.4 Remote I/O, Remote Registers"

(c) "Wr" Word input area (remote input (RWr))

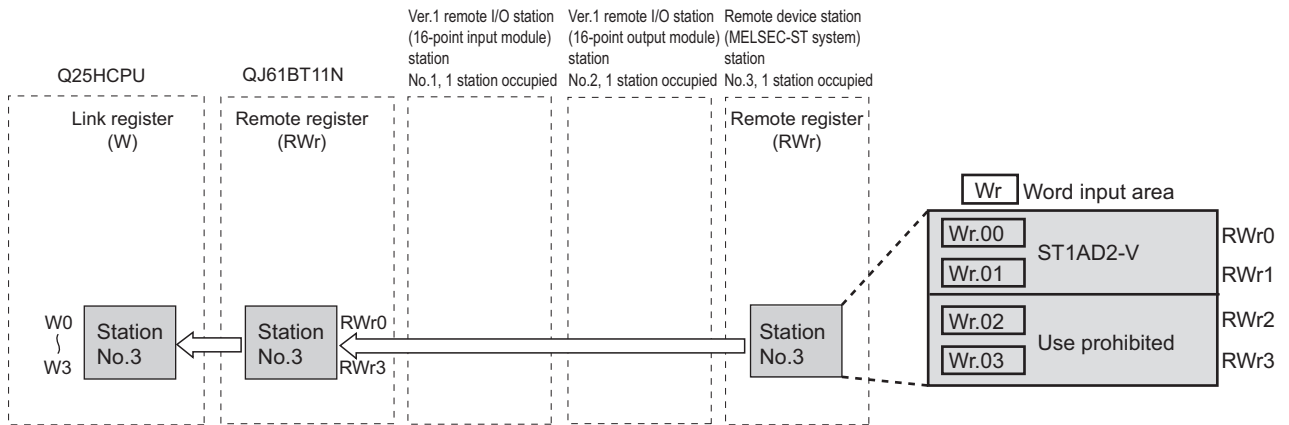

Figure 6.7 "Wr" Word input area (remote input (RWr))

Table 6.5 "Wr" Word input area assignment sheet

Master station		Remote device station (MELSEC-ST system)			
Device	Remote register (RWr)	Slice position No.	Module name	Wr.n	Data name
W1000	RWr0	2	ST1AD2-V	Wr.00	CH1 digital value
W1001	RWr1			Wr.01	CH2 digital value
W1002	RWr2			Wr.02	Use prohibited
W1003	RWr3			Wr.03	Use prohibited

6.4 Program Examples

A program example is shown below.

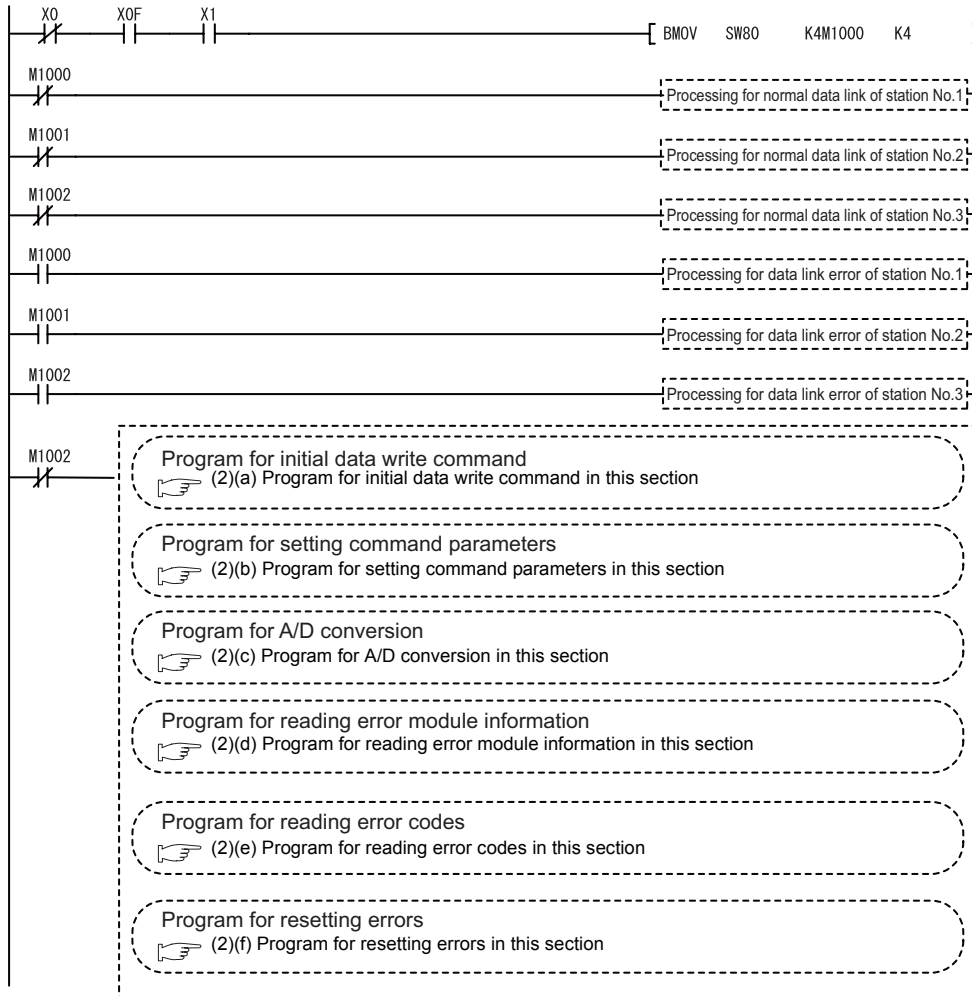

(1) Device assignments in program examples

The devices used common to the program examples (2) in this section and later are shown below.

For devices used for each program example, refer to the following.

☞ (2) Program examples in this section

(a) Special relay (SM) and special register (SD)

Table 6.6 Special relay (SM) and special register (SD)

Device	Application	Device	Application
SM0	Diagnostic error	SD0	Diagnostic error

(b) Devices used by the QJ61BT11N (master station)

Table 6.7 Devices used by the QJ61BT11N (master station)

Device	Application	Device	Application
X00	Module error		-
X01	Own data link status		
X0F	Module READY		
SB0 to SB1FF	Link special relay (SB) of the QJ61BT11N	SW0 to SW1FF	Link special register (SW) of the QJ61BT11N

(c) Devices used by the user

Table 6.8 Devices for checking Other station data link status

Device	Application	Device	Application
M1000	Other station data link status (station No.1)	M1002	Data link status of the ST1H-BT (station No.3)
M1001	Other station data link status (station No.2)		-

(2) Program examples

(a) Program for initial data write command

Execute Initial data individual write request (command No.: 8107H) with the dedicated instruction (RDMSG) of the master station to set command parameters.

1) Setting details of command parameters

In this program, the following parameters are set.

Table 6.9 Setting details of command parameters

Item		Setting	Reference section
ST1AD2-V	CH1 Input range setting	-10 to 10V	Section 8.3.2
	CH2 Input range setting	-10 to 10V	

2) Device assignments in the program example

Table 6.10 Initial data write command setting

Device	Application	Device	Application
M2000	Completion device	D1000 to D1004	Control data
M2001	Completion status indicator device	D1500 to D1506	Send data (execution data of the command)
M3000	Initial data individual write flag	D1700 to D1704	Receive data (result data of the command)

3) Program example

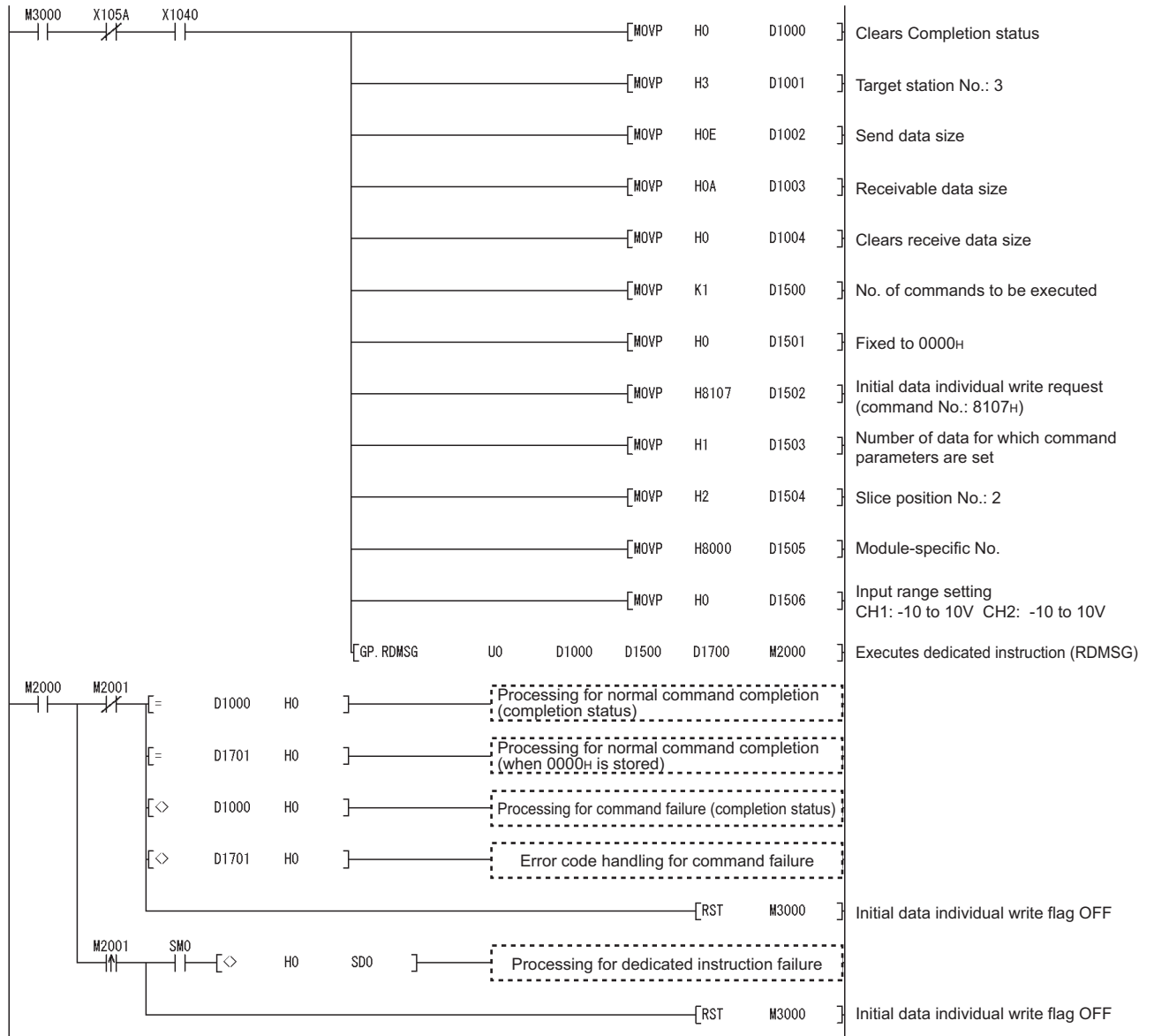

(b) Program for setting command parameters

Execute a command of the ST1AD with the dedicated instruction (RDMSG) of the master station to set command parameters.

1) Setting details of command parameters

In this program, the following command parameters are set.

Table 6.11 Setting details of command parameters

	Item	Setting	Reference section
ST1AD2-V	CH1 A/D conversion enable/disable setting	A/D conversion enabled	Section 8.5.1
	CH2 A/D conversion enable/disable setting	A/D conversion enabled	
	CH1 Time/number of times specification, Sampling process/averaging process setting	Time/number of times specification: Time averaging Sampling process/averaging process setting: Averaging process	Section 8.5.2
	CH2 Time/number of times specification, Sampling process/averaging process setting	Time/number of times specification: None Sampling process/averaging process setting: Sampling process	
	CH1 Average time/average number of times setting	500ms	Section 8.5.4
	CH2 Average time/average number of times setting	No setting	
	CH1 Alarm output setting	Alarm output enabled	Section 8.5.2
	CH2 Alarm output setting	No alarm output	
	CH1 Disconnection detection setting	Disconnection detection enabled	
	CH2 Disconnection detection setting	No disconnection detection	
	CH1 Upper upper limit value, Upper lower limit value	Upper upper limit value: 3000 Upper lower limit value: 3000	Section 8.5.5
	CH2 Upper upper limit value, Upper lower limit value	No setting	
	CH1 Lower upper limit value, Lower lower limit value	Lower upper limit value: 100 Lower lower limit value: 100	Section 8.5.6
	CH2 Lower upper limit value, Lower lower limit value	No setting	
	50/60Hz notch filter specification	Notch filtering enabled for all channels (60 ± 3Hz)	Section 8.5.3

2) Device assignments in the program example

Table 6.12 Initial data write command setting

Device	Application	Device	Application
M2000	Completion device	D1000 to D1004	Control data
M2001	Completion status indicator device	D1100 to D1104	Send data (execution data for each command execution)
M4000	A/D conversion enable/disable setting write flag	D1300 to D1304	Receive data (execution data for each command execution)
M4001	Operation condition specification value write flag	D2000 to D2024	Send data (when multiple commands are simultaneously executed)
M4002	Time/number of times setting write flag	D3000 to D3024	Receive data (when multiple commands are simultaneously executed)
M4003	CH1 upper upper limit value/upper lower limit value setting write flag	-	-
M4004	CH1 lower upper limit value/lower lower limit value setting write flag		
M4005	Notch filter setting write flag		
M4006	Command parameter write flag (when multiple commands are simultaneously executed)		

- 3) Program example (when multiple commands are simultaneously executed)
The following is a program example for simultaneous execution of multiple commands.

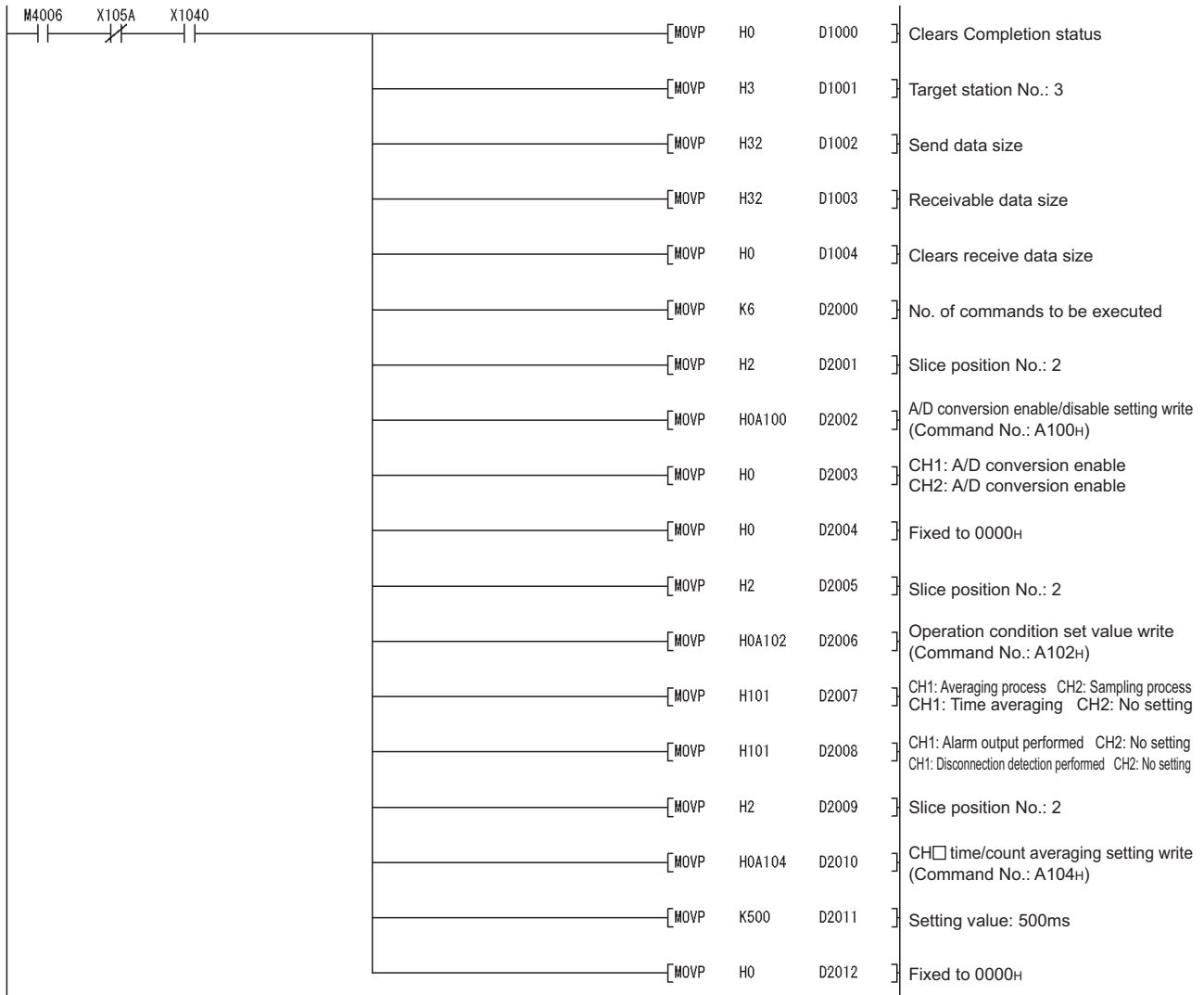

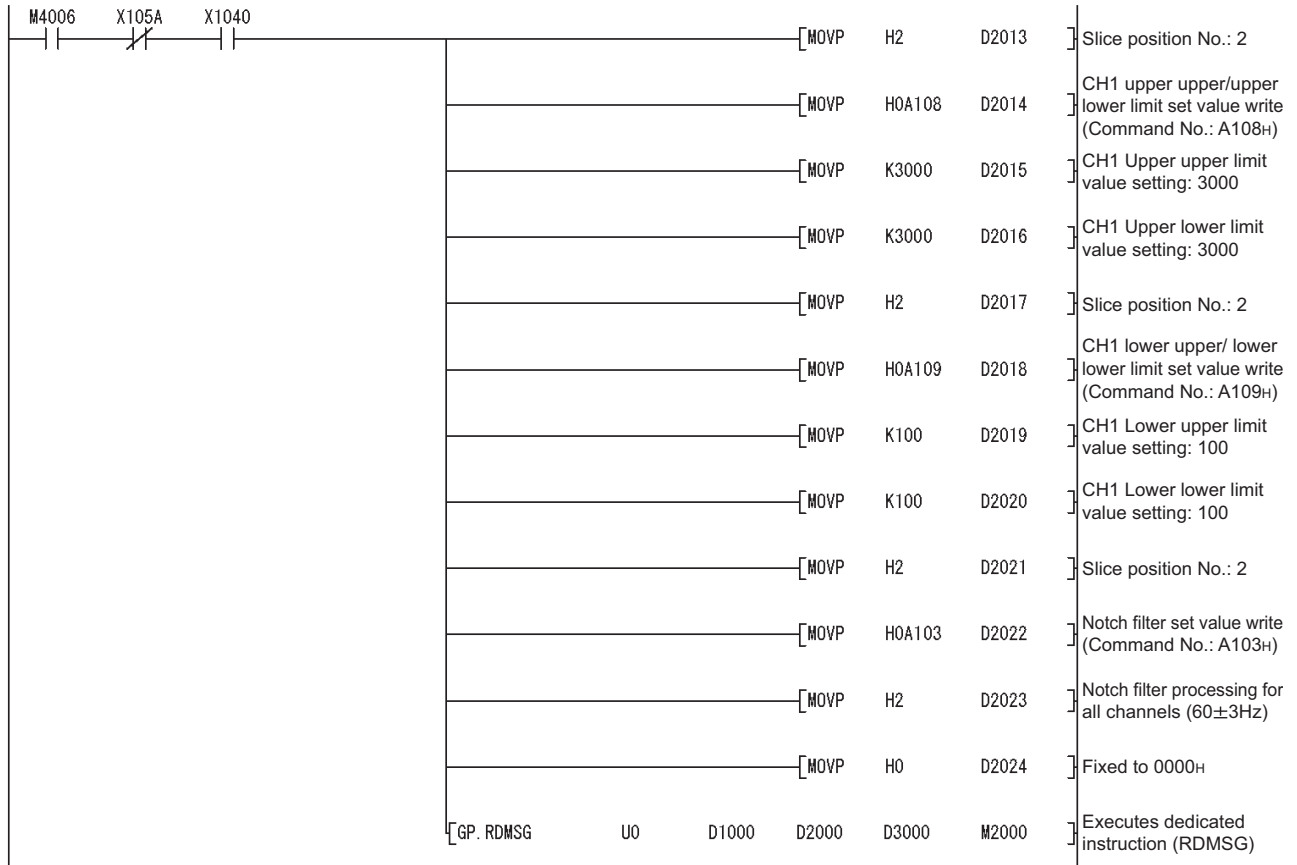

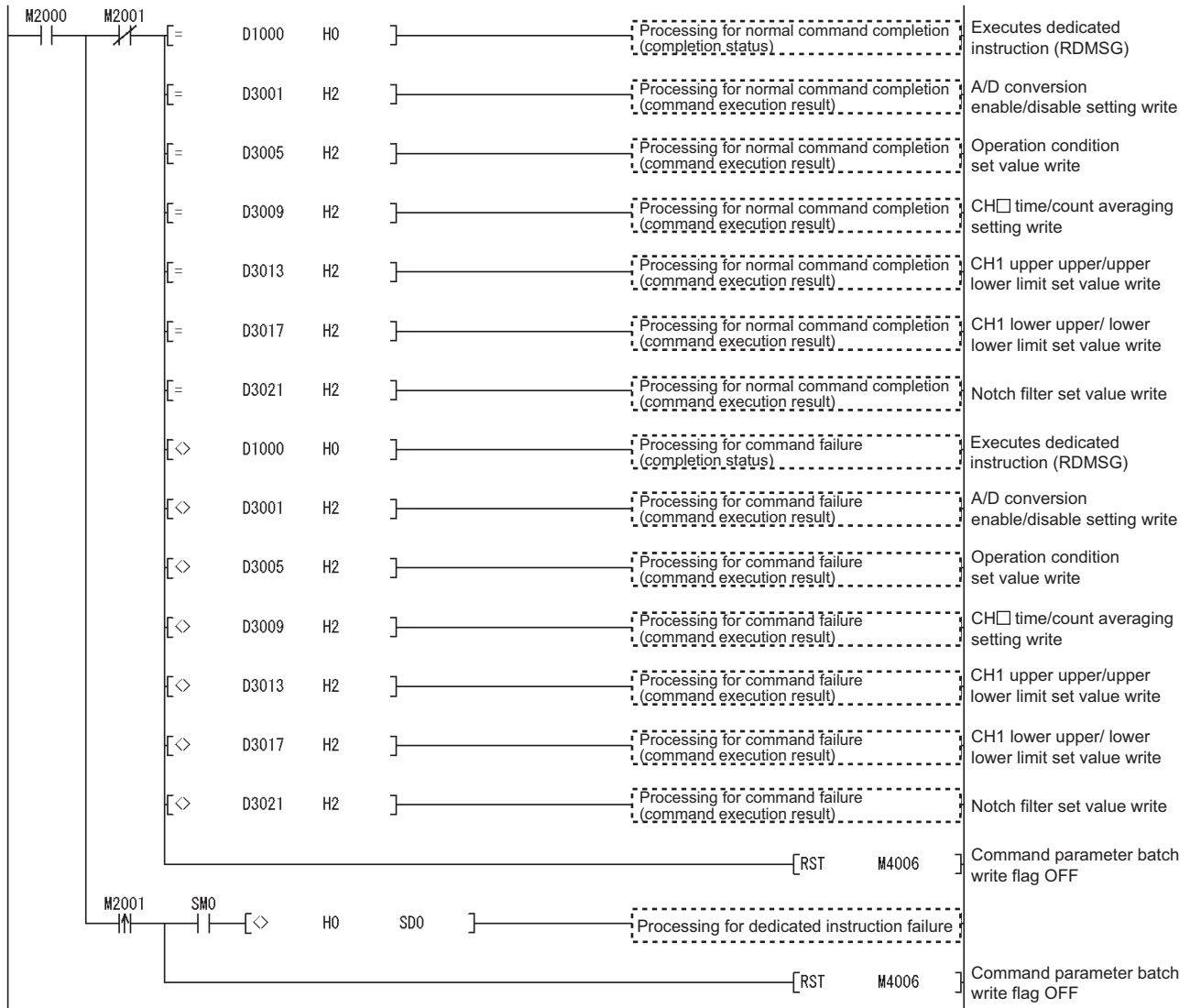

4) Program example (when one command is executed at a time)
 The following is a program example for executing a command at a time.

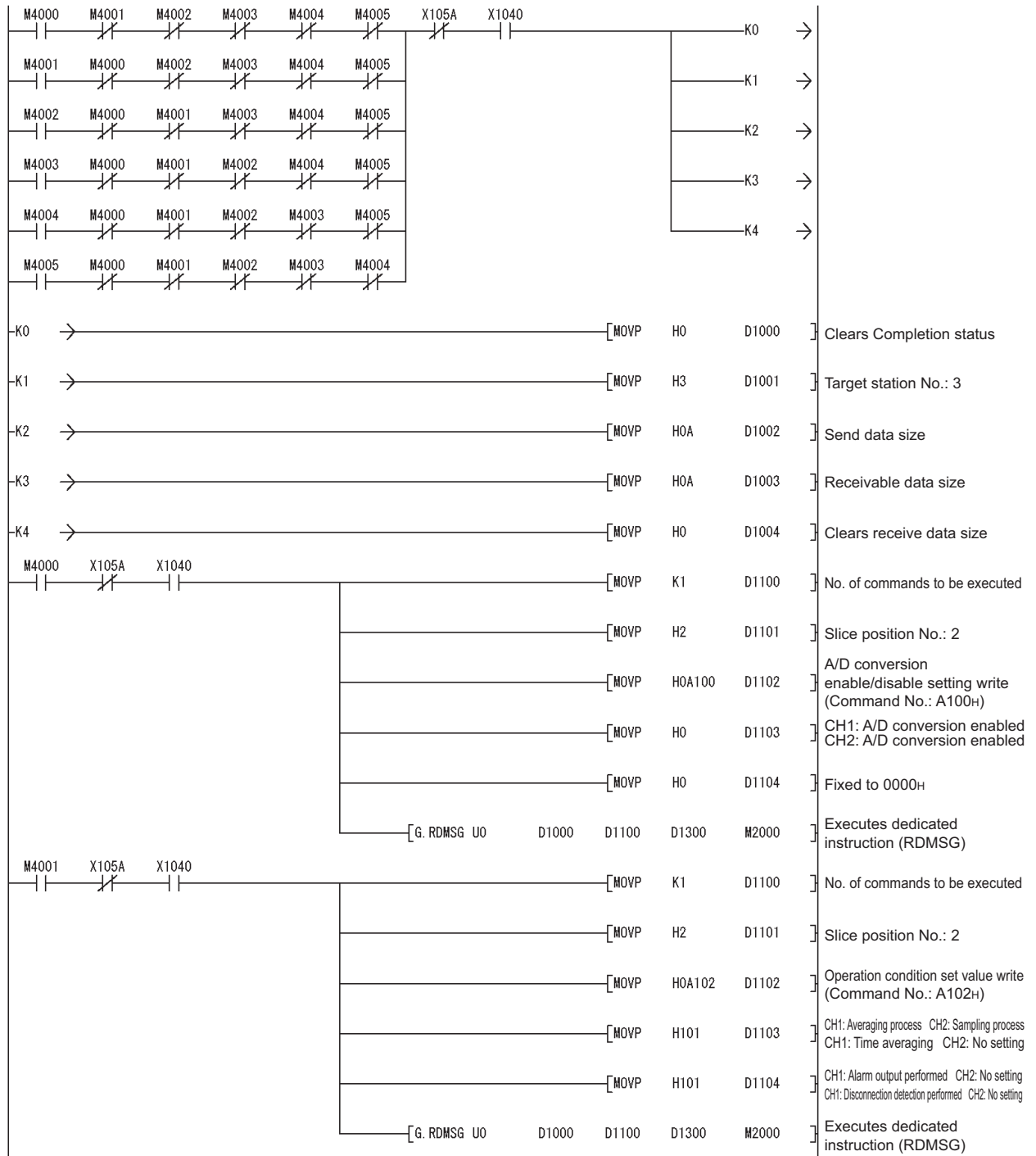

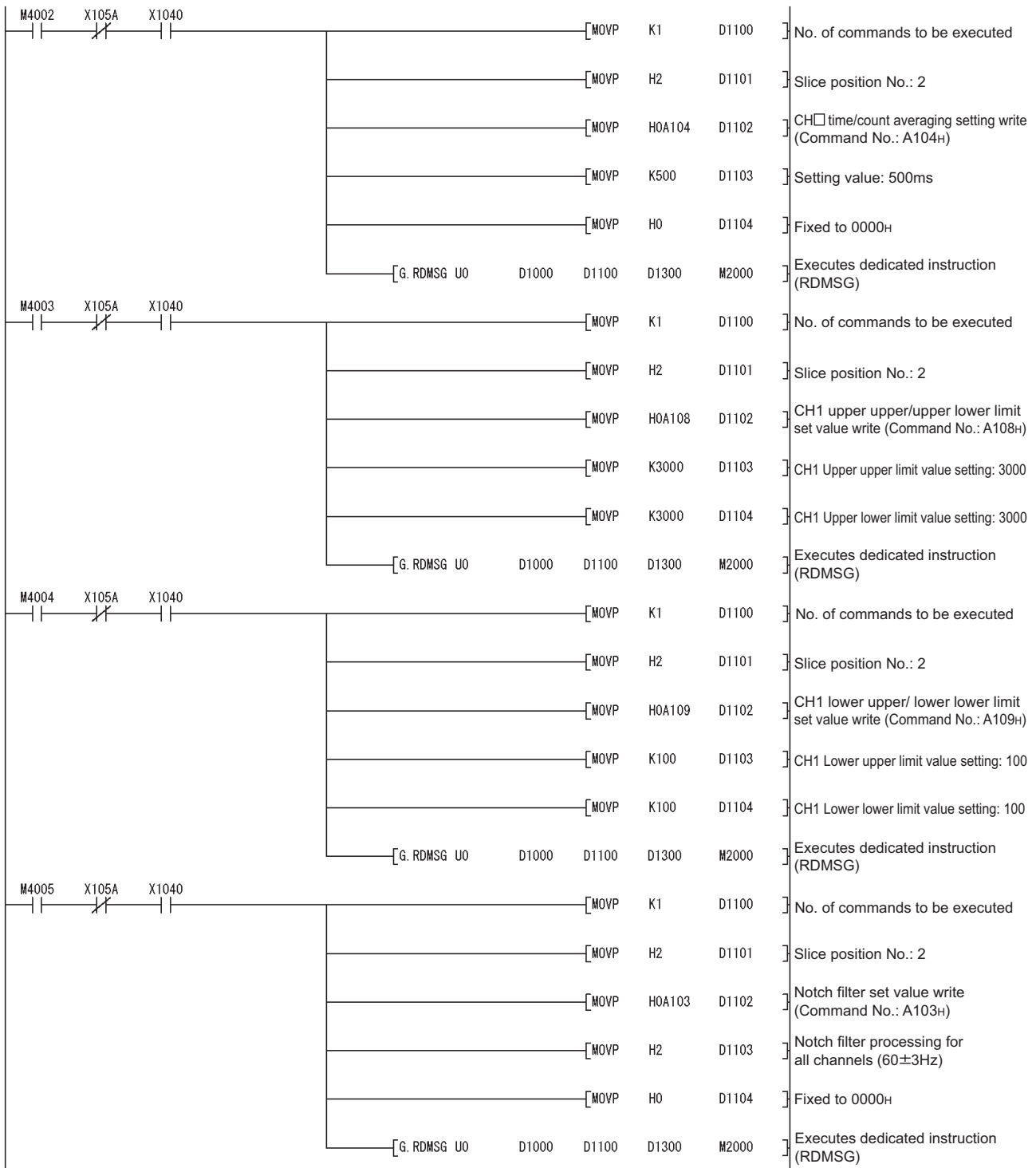

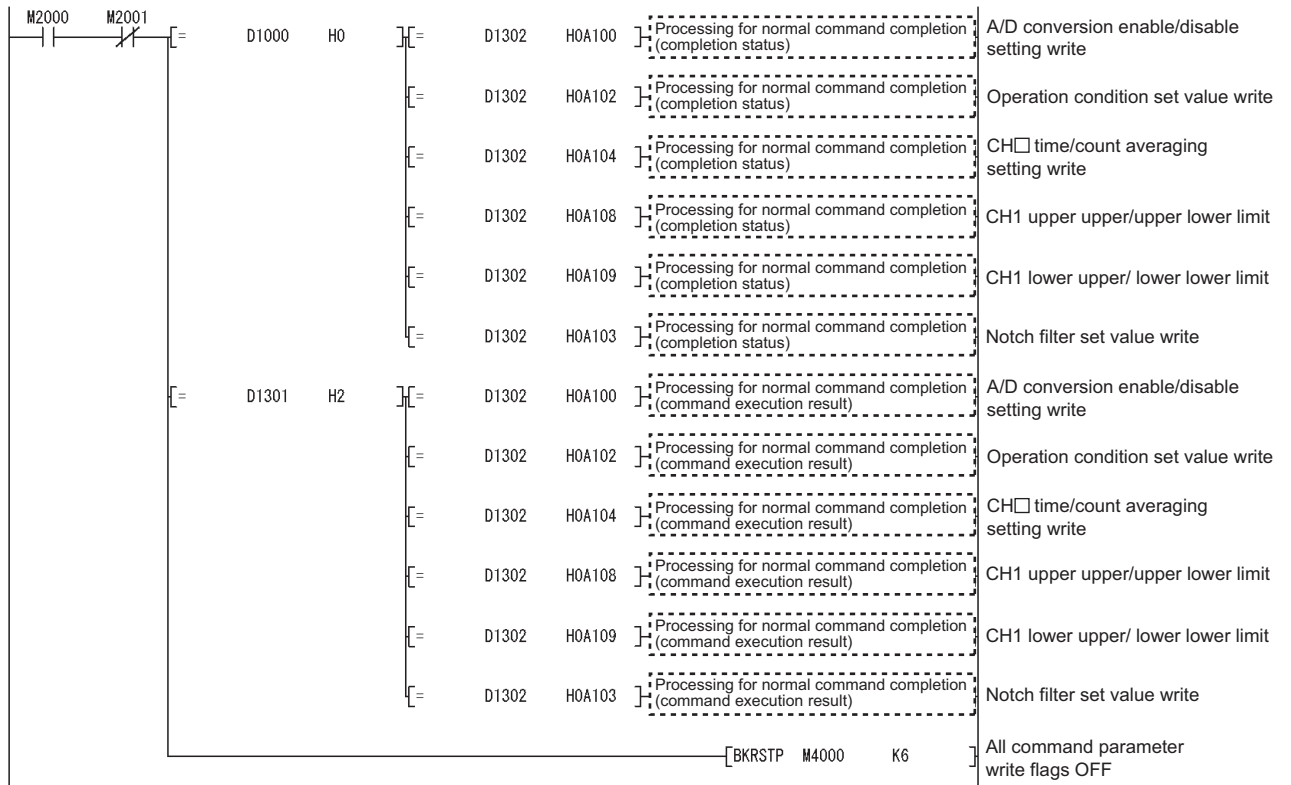

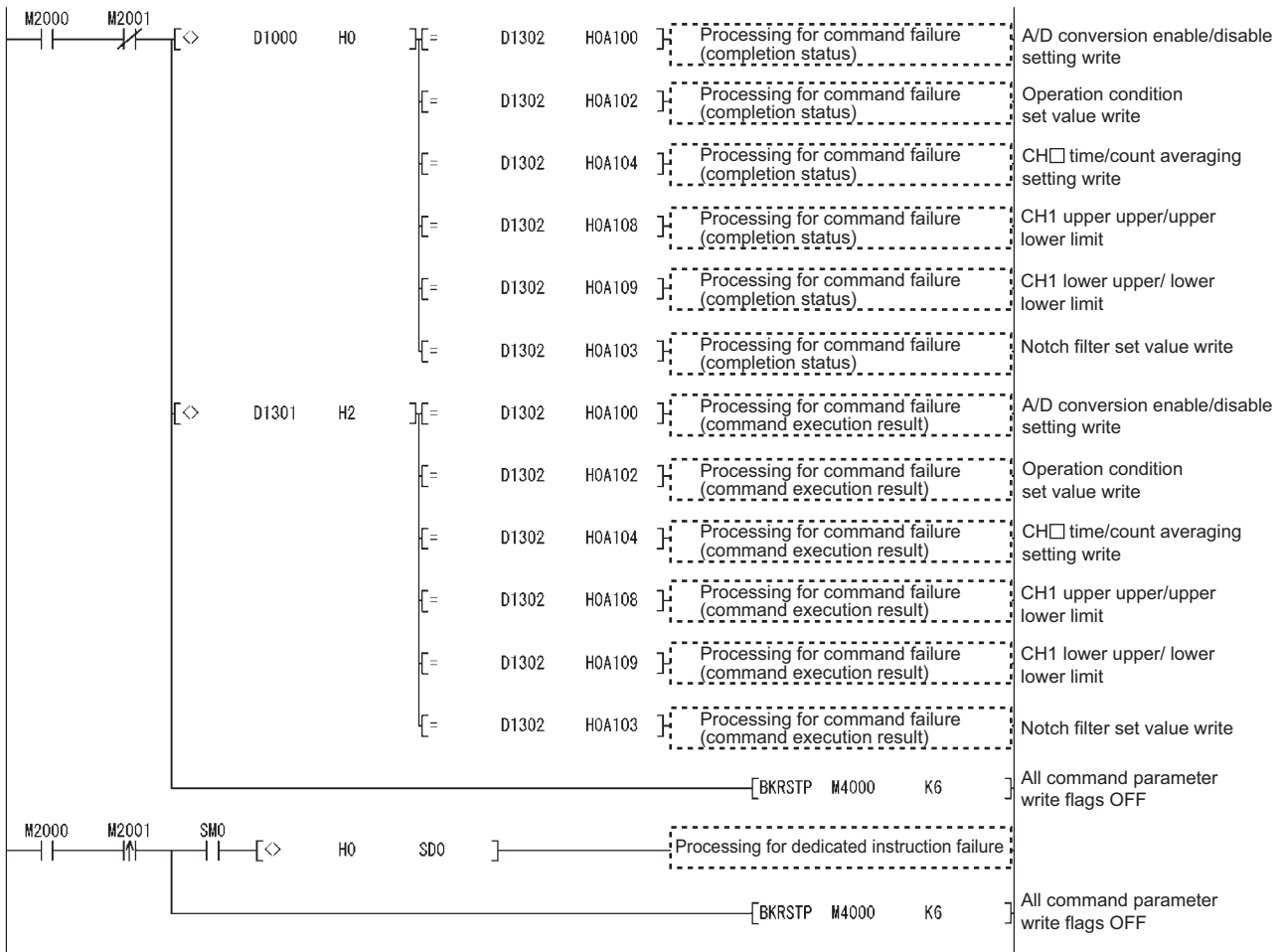

(c) Program for A/D conversion
A/D conversion is executed.

1) Device assignment in the program example

Table 6.13 A/D conversion

Device	Application	Device	Application
M4100	A/D conversion enable/disable setting write flag		

2) Program example

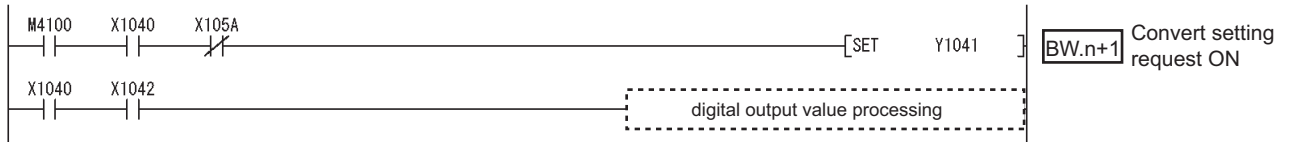

(d) Program for reading error module information

Execute Error module information read request (command No.: 0103H) with the dedicated instruction (RDMSG) of the master station to read the error module information.

Error module information read request is a command of the head module. For details of the command, refer to the following.

 MELSEC-ST CC-Link Head Module User's Manual, "8.2.4 Error module information read request"

1) Device assignments in the program example

Table 6.14 Reading error module information

Device	Application	Device	Application
M2000	Completion device	D1000 to D1004	Control data
M2001	Completion status indicator device	D1100 to D1106	Send data (execution data of the command)
M6000	Error module information storage enabled	D1300 to D1304	Receive data (result data of the command)
-	-	D4000	Error module information read target

2) Program example

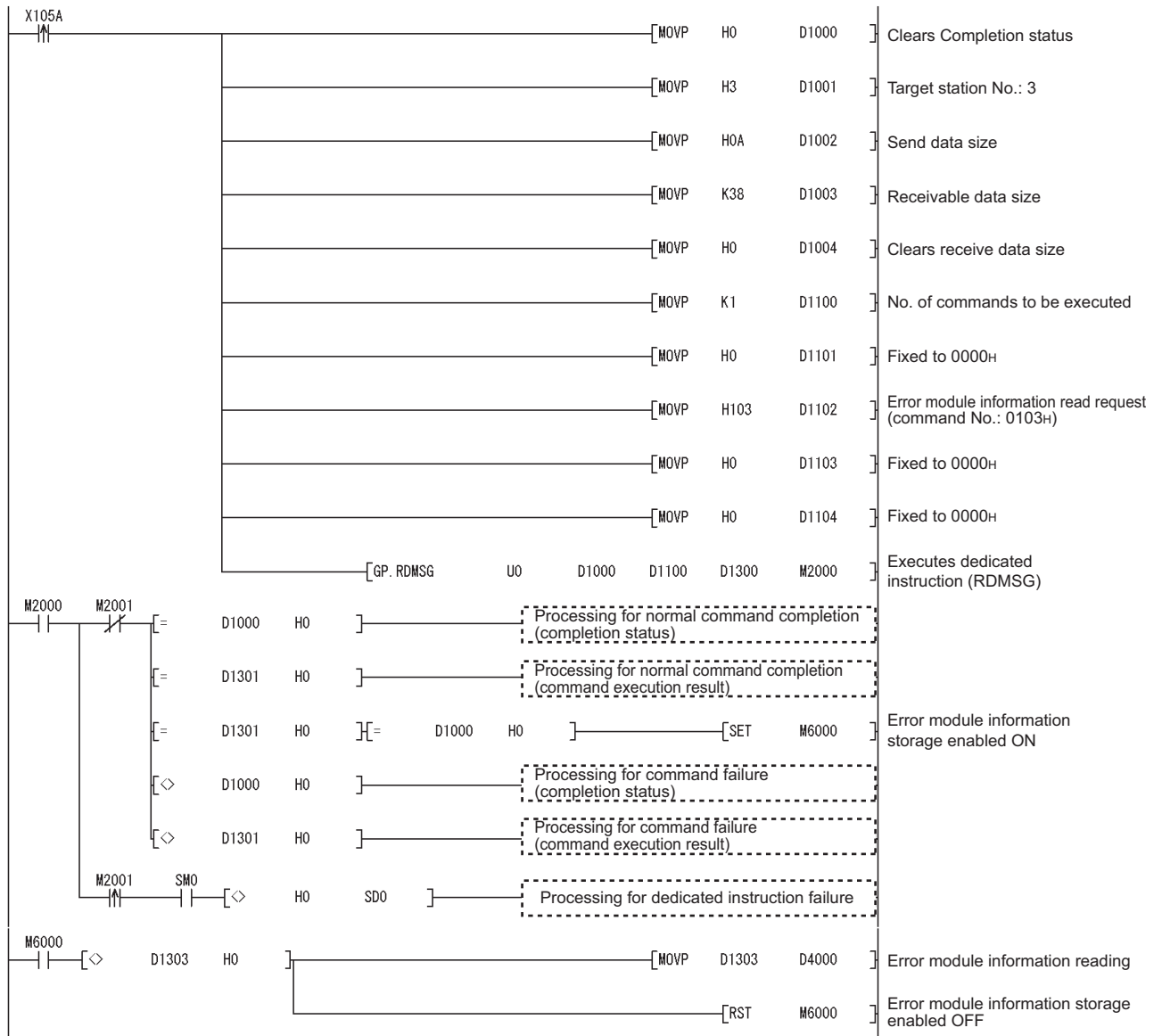

1

OVERVIEW

2

SYSTEM CONFIGURATION

3

SPECIFICATIONS

4

SETUP AND PROCEDURES BEFORE OPERATION

5

GX Configurator-ST

6

PROGRAMMING

7

ONLINE MODULE CHANGE

8

COMMANDS

(e) Program for reading error codes

Execute Error code read request (command No.: 8101H/0101H) with the dedicated instruction (RDMSG) of the master station to read an error code.

1) Device assignments in the program example

Table 6.15 Error code reading

Device	Application	Device	Application
M2000	Completion device	D1000 to D1004	Control data
M2001	Completion status indicator device	D1100 to D1104	Send data (execution data of the command)
M5002	Error handling flag	D1300 to D1304	Receive data (result data of the command)
M6001	Error code storage enabled	D4000	Error module information read target  (2)(d) Program for reading error module information in this section
-	-	D4001	Error code read target

2) Program example

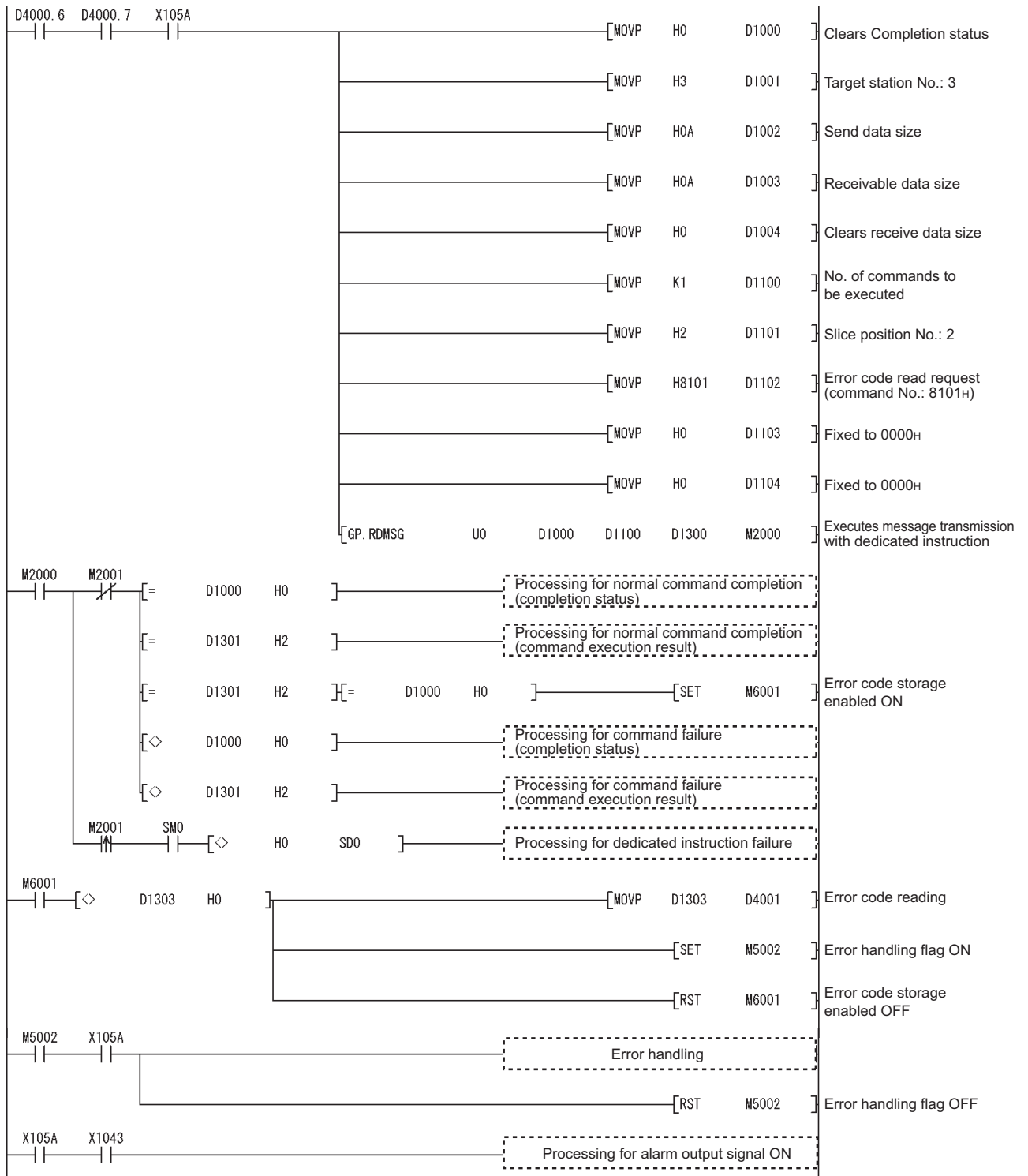

1

OVERVIEW

2

SYSTEM CONFIGURATION

3

SPECIFICATIONS

4

SETUP AND PROCEDURES BEFORE OPERATION

5

GX Configurator-ST

6

PROGRAMMING

7

ONLINE MODULE CHANGE

8

COMMANDS

(f) Program for resetting errors

Execute Error clear request (command No.: 8104H/0104H) with the dedicated instruction (RDMSG) of the master station to reset errors.

Error clear request is a command of the head module.

For details of the command, refer to the following.

 MELSEC-ST CC-Link Head Module User's Manual, "8.2.5 Error clear request"

1) Device assignments in the program example

Table 6.16 Error resetting

Device	Application	Device	Application
M2000	Completion device	D1000 to D1004	Control data
M2001	Completion status indicator device	D1100 to D1106	Send data (execution data of the command)
M5003	Error reset request flag	D1300 to D1304	Receive data (result data of the command)

2) Program example

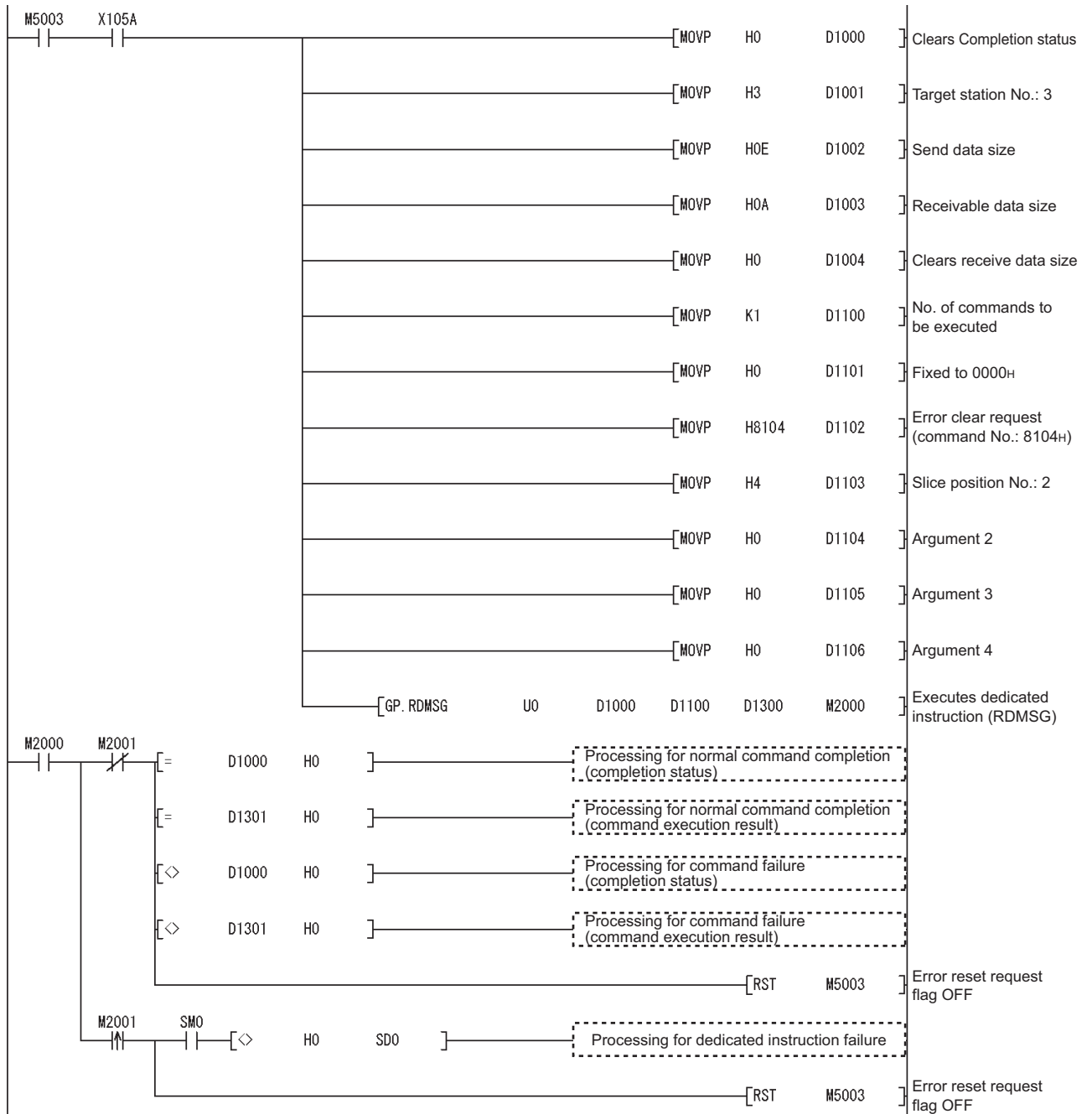

CHAPTER7 ONLINE MODULE CHANGE

Before performing online module change, always read through the following.

☞ MELSEC-ST CC-Link Head Module User's Manual, "4.6 Online Module Change Function"

This chapter describes the specifications of online module change.

- (1) **Perform online module change with the buttons of the head module or using GX Configurator-ST.**
- (2) **Existing command parameters and offset/gain setting values in the user range setting are automatically loaded into the new module.**
- (3) **Using GX Configurator-ST allows offset/gain setting during online module change.**
When higher accuracy is required, perform offset/gain setting during online module change using GX Configurator-ST.

7.1 Precautions for Online Module Change

The following are the precautions for online module change.

(1) **System configuration in which online module change is executable**

To perform the online module change, the system configuration must be appropriate for execution of the online module change.

For details, refer to the following.

☞ MELSEC-ST System User's Manual, "3.4 Precautions for System Configuration"

Executing the online module change in an inappropriate system configuration may result in a malfunction or failure.

If the system configuration is not appropriate for online module change, shut off all phases of the external power supply for the MELSEC-ST system to replace a slice module.

(2) **Online module change procedure**

When performing online module change, take the steps described in the following.

☞ Section 7.4.1 When setting is performed using GX Configurator-ST during online module change

☞ MELSEC-ST CC-Link Head Module User's Manual, "4.6 Online Module Change Function"

Failure to do so can cause a malfunction or failure.

(3) **Precaution for external devices during online module change**

Before starting online module change, confirm that the external device connected with the slice module to be removed will not malfunction.

(4) Replaceable slice module

Only the slice modules of the same model name can be replaced online. Replacing a slice module with a different slice module model and adding a new slice module is not allowed.

(5) Number of replaceable slice modules

Only one slice module can be replaced in a single online module change. To replace multiple slice modules, perform a separate online module change for each module.

(6) Command execution during online module change

While an online module change is being executed (while the REL. LED of the head module is on), no command can be executed to the slice module being replaced online.

An attempt to execute a command in such a case will cause an error.

(7) Parameter change during online module change

To change a command parameter of the slice module, which is being changed online (the head module's REL. LED is on), from the master station, wait until the online module change is completed.

(8) The ERR. LED of the head module in online module change status

The ERR. LED of the head module in online module change status will turn on only when an error related to the online module change occurs.

It will not turn on or flash when any other error occurs.

(9) I/O data during online module change

While online module change is being executed for a slice module (while the REL. LED of the head module is on), all the Br.n Bit input area and Wr.n Word input area data of the slice module turn to 0 (OFF).

(10) User setting range accuracy after online module change

After online module change, the accuracy of the user range setting is about three times lower than that before the online module change.

When the user range setting is used, set the offset and gain values again as necessary.

(11) Mode for online module change

Perform online module change in the normal mode.

(12) Forced output test during online module change

The forced output test of GX Configurator-ST cannot be used for the module being changed online.

After completion of online module change, perform the forced output test.

7.2 Preparations for Online Module Change

Have GX Configurator-ST ready to use when replacing the ST1AD online. Depending on the module failure status, the command parameters and offset/gain setting values in the user range setting may not be saved into the head module. For the procedure for setting parameters and offset/gain values during online module change, refer to the following.

 Section 7.4.1 When setting is performed using GX Configurator-ST during online module change

When GX Configurator-ST is unavailable, make the preparations described below. Failure to do so may cause the values such as offset/gain setting values in the user range setting not be imported to the new module, if they cannot be saved to the head module.

(1) Command parameters

When GX Configurator-ST is unavailable, the command parameters must be set by the commands after completion of online module change.

Provide a command parameter setting program in the master station program.

For the command parameter setting program, refer to the following.

 Section 6.4 Program Examples

(2) Offset/gain setting values

When the user range setting is used and GX Configurator-ST is unavailable, offset/gain values must be set by commands after completion of online module change.

Provide an offset/gain setting program in the master station program.

For the offset/gain setting program, refer to the following.

 Section 4.5 Offset/Gain Settings

POINT

When GX Configurator-ST is unavailable, set the command parameters and offset/gain setting values after the module has operated once by default.

7.3 Disconnecting/connecting the External Device for Online Module Change

Disconnect and connect the external device according to the following procedure.

(1) Disconnection

Power off the external device.

(2) Connection

Power on the external device.

7.4 Online Module Change Procedure

This section explains how to set the command parameters or offset/gain values set in the user range setting during online module change when they could not be saved in the head module or when higher accuracy is required with the user range setting used.

For other online module change procedures, refer to the following.

 MELSEC-ST CC-Link Head Module User's Manual, "4.6 Online Module Change Function"

7.4.1 When setting is performed using GX Configurator-ST during online module change

This section describes the parameter setting or offset/gain setting is performed using GX Configurator-ST during online module change.

POINT

If a slice module different from the target one is selected by mistake, restart the operation by any of the following.

(1) On the screen shown in (c)

Click the button on screen (c) to terminate online module change.

(2) On the screen shown in (d)

Do not change the slice module, click the button, and perform the operations in steps (g), (l), and (m) to complete the online module change once.

(3) During operation (g)

Mount the removed slice module again, click the button, and perform the operations (l) and (m) to complete the online module change once.

[Preparation for replacing ST1AD]

(a) Select the ST1AD to be replaced online on the "System Monitor" screen.

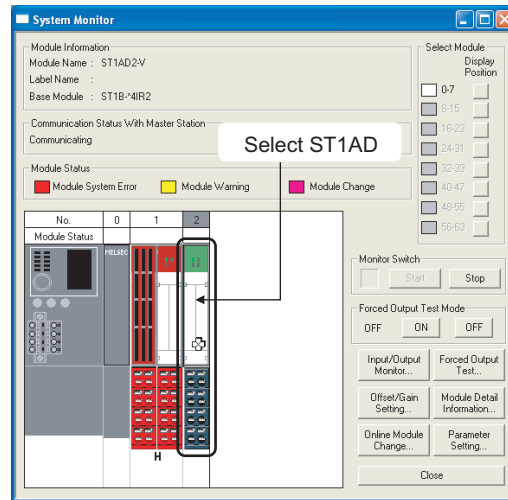

Figure 7.1 System Monitor screen

(b) Click the Online Module Change button on the "System Monitor" screen.

Then, confirm that the RUN LED of the selected ST1AD is flashing at 0.25s intervals.

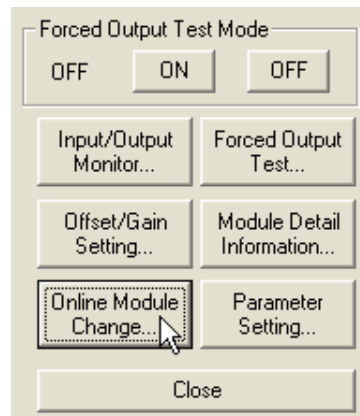

Figure 7.2 Online Module Change button

Remark

In addition to the above, the following operations are also available.

- Select [Diagnostics] → [Online Module Change].
- Right-click the ST1AD selected in (a), and click [Online Module Change] on the menu.

- (c) Confirm that the ST1AD displayed as "Target Module" is the ST1AD to be replaced and click the button.

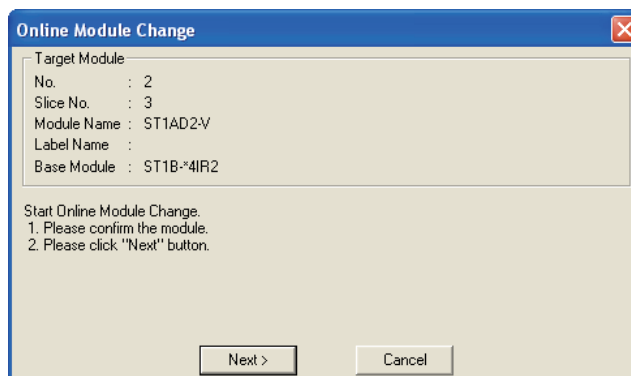

Figure 7.3 Online Module Change screen

- 1) Clicking the button validates the settings and the following will be performed.
 - The head module is placed into the online module change mode.
 - The command parameters and user range setting's offset/gain setting values of the ST1AD to be changed are saved into the head module.

Clicking the button stops online module change.

Clicking the button returns the screen back to the status before performing (b).
- 2) After clicking the button, confirm the following module states.
 - The REL. LED of the head module is on.
 - The RUN LED of the target ST1AD is off.
 - The "Module Status" indicator of the target module has turned purple on the "System Monitor" screen.
- 3) If the command parameters and user range setting's offset/gain setting values could not be read from the ST1AD, the REL. LED and ERR. LED of the head module turn on and an error message is displayed on the screen by the operation in step (g).
Identify the error and take action. (☞ Section 9.1 Error Code List)

For details of the error code reading and error codes of the head module, refer to the following.

(☞ MELSEC-ST CC-Link Head Module User's Manual, "9.7 Error Codes")
To set parameters and offset/gain values for a new ST1AD, perform the operations described in (d) and later.

[Disconnection from external device]

- (d) As the following screen appears, power off the external device connected to the ST1AD to be removed.

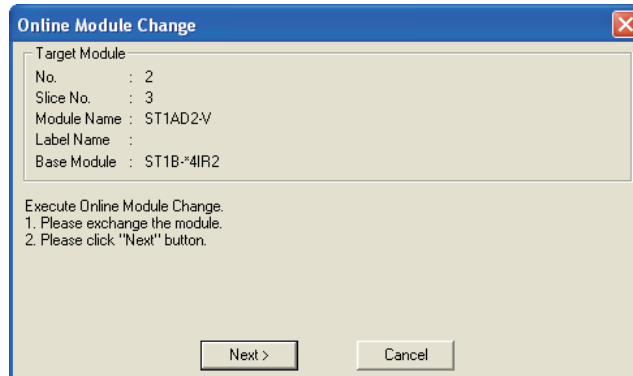

Figure 7.4 Connection to external device after replacement

POINT

If the external device cannot be powered off, shut off all phases of the external power for the MELSEC-ST system and replace the ST1AD.

[Replacing ST1AD]

- (e) Remove the ST1AD and replace with a new one.

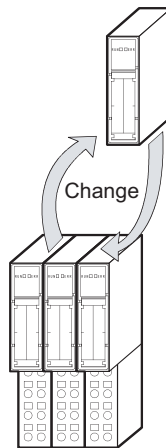

Figure 7.5 Replacing ST1AD

[Connection to external device after replacement]

- (f) Mount a new ST1AD. And then, power on the external device.

[Operations after external device connection]

(g) After connecting to the external device, click the button on the screen in (d).

- 1) Clicking the button performs the following.
 - Checking whether the model name of the newly mounted slice module is the same as that of the removed one.
 - Writing the command parameters and user range setting's offset/gain setting values, which were saved in the head module in (c), to the mounted ST1AD.

Clicking the button stops online module change.

Terminate the online module change by the following procedure.

- On the restarted screen shown in (a), select the same slice module. If a different module is selected, an error occurs.
 - Perform the operation (b) to display the screen in (k), and click the button to terminate the online module change.
- 2) After clicking the button, confirm the following module statuses.
 - The REL. LED of the head module is flashing.
 - The RUN LED of the newly mounted ST1AD is flashing (at 0.25s intervals).

If the parameter settings or user range setting's offset/gain setting values could not be written to the ST1AD, the REL. LED and ERR. LED of the head module turn on and the following screen appears.

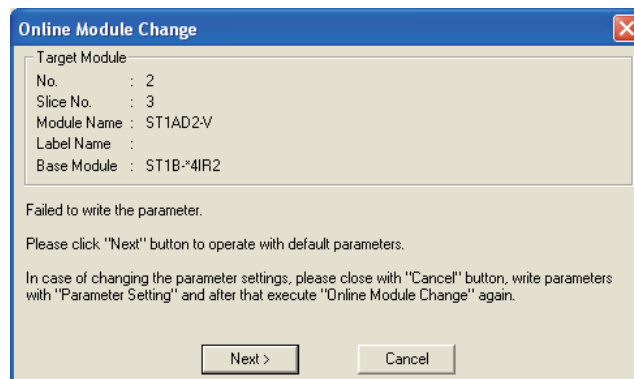

Figure 7.6 Error screen

Confirm the error and take corrective actions.

For details of the error codes of the head module, refer to the following.

(MELSEC-ST CC-Link Head Module User's Manual, "9.7 Error Codes")

[Parameter setting/offset/gain setting]

- (h) Click the button to stop the online module change.

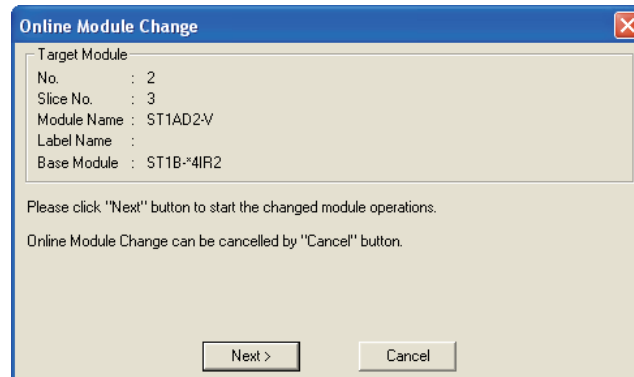

Figure 7.7 Stop of online module change

- (i) Click the button.

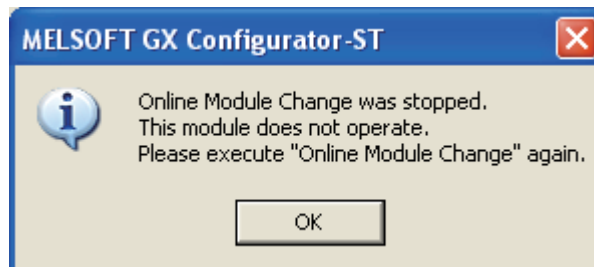



Figure 7.8 Confirmation dialog

- (j) Set parameters or offset/gain values.
Take the procedures described in the following.
-  Section 5.3 Parameter Setting
 -  Section 5.6 Offset/Gain Setting
- The following describes the notes on the parameter setting and offset/gain setting during online module change.

POINT

- (1) As the system is already in the diagnostic mode, the mode need not be changed.
- (2) When setting parameters during online module change, write them to both the RAM and ROM.
After the control resumes, the module will operates with the setting written on the RAM.
- (3) If the parameter settings and user range setting's offset/gain setting values could not be read from the old ST1AD, command parameters might have been written during operation (g).
Using GX Configurator-ST, check whether the command parameters have been written.
- (4) When offset/gain setting was made during online module change, the RUN LED of the ST1AD flashes at 0.25s intervals even in the offset/gain setting mode.

[Processing after parameter setting or offset/gain setting]

- (k) After parameter setting or offset/gain setting, execute the operations (a) and (b) to resume the online module change.

* Select the same ST1AD as the one selected before the online module change was stopped. If the selected ST1AD is different, an error will occur.

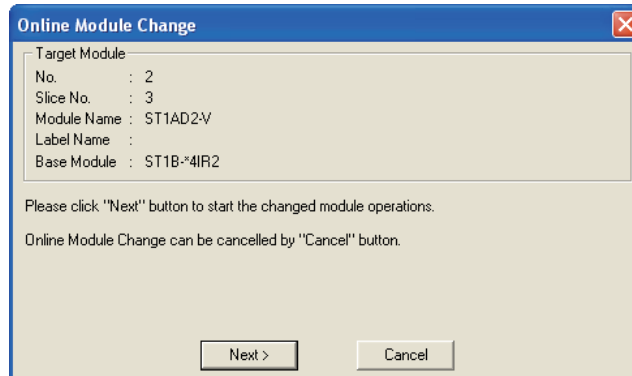

Figure 7.9 Online Module Change window

- (l) Clicking the button releases the head module from the online module change mode.
- 1) Clicking the button performs the following.
 - The head module exits the online module change mode.
 - I/O data refresh is restarted.

Clicking the button stops online module change.

When stopped, the screen in (a) is displayed.

Terminate the online module change by the following procedure.

 - On the restarted screen shown in (a), select the same slice module. If a different module is selected, an error occurs.
 - Follow the instructions in (b) to display the screen in (c), and click the button.
 - 2) After clicking the button, confirm the following module statuses.
 - The REL. LED of the head module is off.
 - The RUN LED of the newly mounted ST1AD is on.
 - The "Module Status" indicator of the target ST1AD has turned white on the "System Monitor" screen.
 - 3) If the head module cannot exit the online module change mode, both the REL. LED and ERR. LED of the head module turn on.
- Confirm the error and take corrective actions. (☞ MELSEC-ST CC-Link Head Module User's Manual, "9.7.2 Error code list")

[Completion]

(m) The following screen appears showing that online module change has been completed.

Click the button.

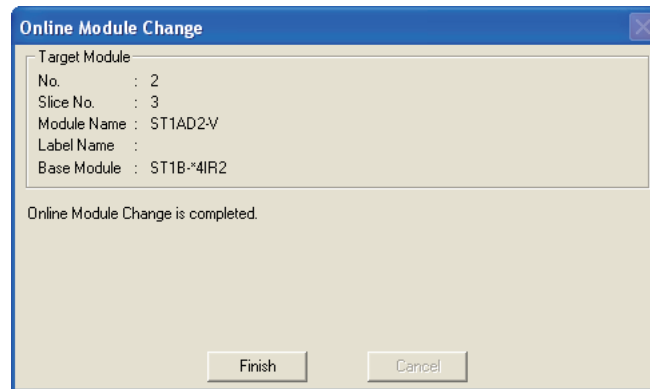

Figure 7.10 Completion of online module change

CHAPTER8 COMMANDS

This chapter explains the commands.

8.1 Command List

(1) About commands

A command is executed by transmitting a message to the MELSEC-ST system with a dedicated instruction (RDMSG) of the master station.

For the command execution procedure, refer to the following.

 MELSEC-ST CC-Link Head Module User's Manual, "8.1 Command execution method and procedures"

(2) When two command numbers are assigned to one command

Use command number 8000H or higher.

Commands, with the number 7FFFH and smaller, are used for importing existing sequence programs from the ST1H-PB (MELSEC-ST PROFIBUS-DP head module) to ST1H-BT (MELSEC-ST CC-Link head module).

(3) Command list

The list of commands that are executable in the ST1AD and conditions for respective command executions are shown in Table 8.1.

Table 8.1 Command list (1/2)

Command			Description	Execution condition	Reference section
Command type	Command No.	Command name			
Common command	8100H 0100H	Operating status read request	Reads the operating status of the ST1AD..	-	Section 8.2.1
	8101H 0101H	Error code read request	Reads an error code and alarm information of the ST1AD.	-	Section 8.2.2
Initial data write command	8106H	Initial data batch write request	Writes command parameters to multiple ST1ADs all at once.	Condition 1	Section 8.3.1
	8107H 0107H	Initial data individual write request	Writes command parameters to a single ST1AD.	Condition 1	Section 8.3.2
ST1AD parameter setting read command	9100H 1100H	A/D conversion enable/disable setting read	Reads the A/D conversion enable/disable setting from RAM of the ST1AD.	-	Section 8.4.1
	9101H 1101H	A/D conversion channel read	Reads current A/D conversion enable/disable setting and A/D conversion completion status.	-	Section 8.4.2
	9102H 1102H	Operation condition setting read	Reads averaging process setting, alarm output setting, and disconnection detection setting from RAM of the ST1AD.	-	Section 8.4.3
	9103H 1103H	Notch filter setting read	Reads notch filter setting from RAM of the ST1AD.	-	Section 8.4.4
	9104H 1104H	CH □ time/count averaging setting read	Reads time or number of times set for averaging processing from RAM of the ST1AD.	-	Section 8.4.5
	9108H 1108H	CH1 upper upper limit/upper lower limit setting read	Reads the upper upper limit value, upper lower limit value, lower upper limit value, or lower lower limit value of alarm output.	-	Section 8.4.6
	9109H 1109H	CH1 lower upper limit/lower lower limit setting read		-	Section 8.4.7
	910AH 110AH	CH2 upper upper limit/upper lower limit setting read		-	Section 8.4.6
	910BH 110BH	CH2 lower upper limit/lower lower limit setting read		-	Section 8.4.7
	9118H 1118H	Input range setting read	Reads the input range setting from RAM of the ST1AD.	-	Section 8.4.8

Table 8.2 Command list (2/2)

Command type	Command		Description	Execution condition	Reference section
	Command No.	Command name			
ST1AD parameter setting write command	A100H 2100H	A/D conversion enable/disable setting write	Writes the A/D conversion enable/disable setting to RAM of the ST1AD.	Condition 1	Section 8.5.1
	A102H 2102H	Operation condition setting write	Writes averaging process setting, alarm output setting, and disconnection detection setting to RAM of the ST1AD.	Condition 1	Section 8.5.2
	A103H 2103H	Notch filter setting write	Writes notch filter setting to RAM of the ST1AD.	Condition 1	Section 8.5.3
	A104H 2104H	CH □ time/count averaging setting write	Writes time or number of times for averaging processing to RAM of the ST1AD.	Condition 1	Section 8.5.4
	A108H 2108H	CH1 upper upper limit/upper lower limit setting write	Writes the upper upper limit value, upper lower limit value, lower upper limit value, or lower lower limit value of alarm output.	Condition 1	Section 8.5.5
	A109H 2109H	CH1 lower upper limit/lower lower limit setting write			Section 8.5.6
	A10AH 210AH	CH2 upper upper limit/upper lower limit setting write			Section 8.5.5
	A10BH 210BH	CH2 lower upper limit/lower lower limit setting write			Section 8.5.6
ST1AD control command	B100H 3100H	Parameter setting read from ROM	Reads parameters from ROM to RAM in the ST1AD.	Condition 1	Section 8.6.1
	B101H 3101H	Parameter setting write to ROM	Writes parameters from RAM to ROM in the ST1AD.	Condition 1	Section 8.6.2
	B102H 3102H	Operation mode setting	Switches the mode of the ST1AD.	Condition 2	Section 8.6.3
	B103H 3103H	Offset channel specification	Specifies an offset channel of offset/gain setting and adjusts the offset value.	Condition 3	Section 8.6.4
	B104H 3104H	Gain channel specification	Specifies a gain channel of offset/gain setting and adjusts the gain value.	Condition 3	Section 8.6.5
	B105H 3105H	User range write	Writes adjusted offset/gain settings to ROM of the ST1AD.	Condition 3	Section 8.6.6

Table 8.3 Conditions for execution

Condition	Description
-	Commands are always executable.
Condition 1	Commands are executable in normal mode and when <input type="checkbox"/> Bw.n+1 Convert setting request is OFF (0).
Condition 2	Commands are only executable in normal mode and when <input type="checkbox"/> Bw.n+1 Convert setting request is OFF (0), or in offset/gain setting mode.
Condition 3	Commands are executable only in offset/gain setting mode.

POINT

If a command execution is attempted while the required condition does not meet, it will fail and "06H" or "13H" will be stored in Cr.n(15-8) Command execution result.

8.2 Common Commands

8.2.1 Operating status read request (Command No.: 8100H/0100H)

Data size	
Cw	4 words (8 bytes)
Cr	4 words (8 bytes)

This command reads the operating status of the ST1AD.

(1) Values set to "Cw" Command execution area

Table 8.4 Values set to "Cw" Command execution area

Cw Command execution area	Setting value
Cw.0	[For execution of command No.8100H] Set a slice position No. of the target ST1AD. (Hexadecimal) [For execution of command No.0100H] Set a start slice No. of the target ST1AD. (Hexadecimal)
Cw.1	Set a command No. to be executed (8100H/0100H). (Hexadecimal)
Cw.2	Fixed to 0000H. (Any other value is treated as 0000H.)
Cw.3	

(2) Values stored in "Cr" Command result area

The command execution result data vary depending on the result data (normal completion or failure) in Cr.0(15-8) Command execution result.

(a) When completed normally ("Cr.0(15-8)" Command execution result is 00H.)

Table 8.5 Values stored in "Cr" Command result area (When completed normally)

Cr Command result area	Result details
Cr.0	[For execution of command No.8100H] The command execution result and slice position No. in hexadecimal are stored in the high and low bytes respectively as shown below. <div style="text-align: center;"> </div>
	[For execution of command No.0100H] The command execution result and start slice No. in hexadecimal are stored in the high and low bytes respectively as shown below. <div style="text-align: center;"> </div>
Cr.1	The executed command No. (8100H/0100H) is stored. (Hexadecimal)

Table 8.5 Values stored in "Cr" Command result area (When completed normally) (Continued)

Cr	Command result area	Result details
	Cr.2	<p>The operating status of the ST1AD is stored.</p> <p>Fixed to 000H. → 0H: Normal mode 1H: System error</p>
	Cr.3	<p>The current operation mode of the ST1AD is stored.</p> <p>Fixed to 000H. → 1H: Normal mode 2H: Offset/gain setting mode</p>

(b) When failed ("Cr.0(15-8)" Command execution result is other than 00H.)

Table 8.6 Values stored in "Cr" Command result area (When failed)

Cr	Command result area	Result details
	Cr.0	<p>[For execution of command No.8100H]</p> <p>The command execution result and slice position No. in hexadecimal are stored in the high and low bytes respectively as shown below</p> <p>Other than 00H: Failure</p>
	Cr.0	<p>[For execution of command No.0100H]</p> <p>The command execution result and start slice No. in hexadecimal are stored in the high and low bytes respectively as shown below.</p> <p>Other than 00H: Failure</p>
	Cr.1	The executed command No. (8100H/0100H) is stored. (Hexadecimal)
	Cr.2	Cw.2 Argument 1 at command execution is stored.
	Cr.3	Cw.3 Argument 2 at command execution is stored.

* 1 When 0FH is stored in Cr.0(15-8) Command execution result, 00H (slice position No. or start slice No. of the head module) is stored in Cr.0(7-0) Start slice No. or Slice position No.

8.2.2 Error code read request (Command No.: 8101H/0101H)

Data size	
Cw	4 words (8 bytes)
Cr	4 words (8 bytes)

This command reads an error code of the ST1AD.

(1) Values set to "Cw" Command execution area

Table 8.7 Values set to "Cw" Command execution area

Cw	Command execution area	Setting value
Cw.0	Cw.0	[For execution of command No.8101H] Set a slice position No. of the target ST1AD. (Hexadecimal)
		[For execution of command No.0101H] Set a start slice No. of the target ST1AD. (Hexadecimal)
Cw.1	Cw.1	Set a command No. to be executed (8101H/0101H). (Hexadecimal)
Cw.2	Cw.2	Fixed to 0000H. (Any other value is treated as 0000H.)
Cw.3	Cw.3	

(2) Values stored in "Cr" Command result area

The command execution result data vary depending on the result data (normal completion or failure) in Cr.0(15-8) Command execution result.

(a) When completed normally ("Cr.0(15-8)" Command execution result is 00H.)

Table 8.8 Values stored in "Cr" Command result area (When completed normally)

Cr	Command result area	Result details
Cr.0	Cr.0	[For execution of command No.8101H] The command execution result and slice position No. in hexadecimal are stored in the high and low bytes respectively as shown below. <div style="text-align: center;"> </div>
		[For execution of command No.0101H] The command execution result and start slice No. in hexadecimal are stored in the high and low bytes respectively as shown below. <div style="text-align: center;"> </div>
Cr.1	Cr.1	The executed command No. (8101H/0101H) is stored. (Hexadecimal)

Table 8.8 Values stored in "Cr" Command result area (When completed normally) (Continued)

Cr	Command result area	Result details
	Cr.2	<p>The error code of the error that is currently occurring in the ST1AD is stored. (Hexadecimal)</p> <p>For details of error codes, refer to the following.</p> <p>☞ Section 9.1 Error Code List</p> <p>When no error is detected, 0000H is stored.</p>
	Cr.3	<p>Alarm information is stored for each channel.</p> <p>Fixed to 000H.</p> <p>b3 b2 b1 b0</p> <ul style="list-style-type: none"> CH1 Alarm status Upper limit value 0: Normal 1: Alarm has occurred. CH1 Alarm status Lower limit value 0: Normal 1: Alarm has occurred. CH2 Alarm status Upper limit value 0: Normal 1: Alarm has occurred. CH2 Alarm status Lower limit value 0: Normal 1: Alarm has occurred.

(b) When failed ("Cr.0(15-8)" Command execution result is other than 00H.)

Table 8.9 Values stored in "Cr" Command result area (When failed)

Cr	Command result area	Result details
	Cr.0	<p>[For execution of command No.8101H]</p> <p>The command execution result and slice position No. in hexadecimal are stored in the high and low bytes respectively as shown below.</p> <p>Other than 00H: Failure (☞ Section 8.7 Values Stored into Command Execution Result)</p>
	Cr.0	<p>[For execution of command No.0101H]</p> <p>The command execution result and start slice No. in hexadecimal are stored in the high and low bytes respectively as shown below.</p> <p>Other than 00H: Failure (☞ Section 8.7 Values Stored into Command Execution Result)</p>
	Cr.1	The executed command No. (8101H/0101H) is stored. (Hexadecimal)
	Cr.2	Cw.2 Argument 1 at command execution is stored
	Cr.3	Cw.3 Argument 2 at command execution is stored.

* 1 When 0FH is stored in Cr.0(15-8) Command execution result, 00H (slice position No. or start slice No. of the head module) is stored in Cr.0(7-0) Start slice No. or Slice position No.

8.3 Initial Data Write Command

8.3.1 Initial data batch write request (Command No.: 8106H)

Data size	
Cw	6 to 20 words (12 to 40 bytes)
Cr	6 words (12 bytes)

This command batch-writes command parameters to the following modules of the same type.

- Head module
- Input module
- Output module
- Intelligent function module

The input range setting is written to RAMs of multiple ST1ADs all at once.

(1) Values set to "Cw" Command execution area

Table 8.10 Values set to "Cw" Command execution area

Cw Command execution area	Setting value
Cw.0	Fixed to 0000H.
Cw.1	Set a command No. to be executed (8106H). (Hexadecimal)
Cw.2	Set command parameters of the head module. (Hexadecimal) ^{*1}
Cw.3	Set command parameters of input modules. (Hexadecimal) ^{*1}
Cw.4	Set command parameters of output modules. (Hexadecimal) ^{*1}
Cw.5	Set the number of the command parameter settings for intelligent function modules in Cw.6 to Cw.19 (number of module types: 0 to 7).
Cw.6	Set a number specific to the ST1AD module and command parameters. (Hexadecimal) This setting is required only when one or more value is set in Cw.5. •For the ST1AD2-V, set 8000H. •For the ST1AD2-I, set 8200H.

Table 8.10 Values set to "Cw" Command execution area (Continued)

Cw	Command execution area	Setting value
		Set command parameters of the ST1AD. (Hexadecimal) This setting is required only when one or more value is set in Cw.5 .
	Cw.7	<div style="text-align: center;"> </div> <p>Fixed to 00H.</p> <p>CH1 Input range setting (ST1AD2-V) 0H: -10 to 10V 1H: 0 to 10V 2H: 0 to 5V 3H: 1 to 5V 7H: User range setting</p> <p>CH1 Input range setting (ST1AD2-I) 0H: 4 to 20mA 1H: 0 to 20mA V 7H: User range setting</p> <p>CH2 Input range setting (ST1AD2-V) 0H: -10 to 10V 1H: 0 to 10V 2H: 0 to 5V 3H: 1 to 5V 7H: User range setting</p> <p>CH2 Input range setting (ST1AD2-I) 0H: 4 to 20mA 1H: 0 to 20mA 7H: User range setting</p>
	Cw.8 to Cw.19	In the same way as in Cw.6 or Cw.7 , set command parameters for other ST1ADs and intelligent function modules. (Two words each)* ²

* 1 For settings of each module, refer to the following.

MELSEC-ST CC-Link Head Module User's Manual, "8.2.7 Initial data batch write request (Command No.: 8106H)"

* 2 For settings of intelligent function modules other than the ST1AD, refer to the following.

Intelligent Function Module User's Manual, "Initial data batch write request (Command No.: 8106H)"

(2) Values stored in "Cr" Command result area

The command execution result data vary depending on the data (normal completion or failure) in Cr.0.

(a) When completed normally ("Cr.0" is 0000H.)

Table 8.11 Values stored in "Cr" Command result area (When completed normally)

Cr	Command result area	Result details																																																																																					
	Cr.0	Error code (0000H when completed normally)																																																																																					
	Cr.1	The executed command No. (8106H) is stored. (Hexadecimal)																																																																																					
	Cr.2	The command parameter setting status after writing is stored for each slice module.																																																																																					
	Cr.3																																																																																						
	Cr.4																																																																																						
	Cr.5																																																																																						
	Cr.5																																																																																						
		<table border="1" style="margin-left: auto; margin-right: auto;"> <thead> <tr> <th></th> <th>b15</th><th>b14</th><th>b13</th><th>b12</th><th>b11</th><th>b10</th><th>b9</th><th>b8</th><th>b7</th><th>b6</th><th>b5</th><th>b4</th><th>b3</th><th>b2</th><th>b1</th><th>b0</th> </tr> </thead> <tbody> <tr> <td>Cr.2</td> <td>15</td><td>14</td><td>13</td><td>12</td><td>11</td><td>10</td><td>9</td><td>8</td><td>7</td><td>6</td><td>5</td><td>4</td><td>3</td><td>2</td><td>1</td><td>0</td> </tr> <tr> <td>Cr.3</td> <td>31</td><td>30</td><td>29</td><td>28</td><td>27</td><td>26</td><td>25</td><td>24</td><td>23</td><td>22</td><td>21</td><td>20</td><td>19</td><td>18</td><td>17</td><td>16</td> </tr> <tr> <td>Cr.4</td> <td>47</td><td>46</td><td>45</td><td>44</td><td>43</td><td>42</td><td>41</td><td>40</td><td>39</td><td>38</td><td>37</td><td>36</td><td>35</td><td>34</td><td>33</td><td>32</td> </tr> <tr> <td>Cr.5</td> <td>63</td><td>62</td><td>61</td><td>60</td><td>59</td><td>58</td><td>57</td><td>56</td><td>55</td><td>54</td><td>53</td><td>52</td><td>51</td><td>50</td><td>49</td><td>48</td> </tr> </tbody> </table> <p style="text-align: right; margin-right: 20px;">← Each bit indicates the corresponding slice position No.</p> <p style="text-align: right; margin-right: 20px;">0: Parameters not set 1: Parameters set</p>		b15	b14	b13	b12	b11	b10	b9	b8	b7	b6	b5	b4	b3	b2	b1	b0	Cr.2	15	14	13	12	11	10	9	8	7	6	5	4	3	2	1	0	Cr.3	31	30	29	28	27	26	25	24	23	22	21	20	19	18	17	16	Cr.4	47	46	45	44	43	42	41	40	39	38	37	36	35	34	33	32	Cr.5	63	62	61	60	59	58	57	56	55	54	53	52	51	50	49	48
	b15	b14	b13	b12	b11	b10	b9	b8	b7	b6	b5	b4	b3	b2	b1	b0																																																																							
Cr.2	15	14	13	12	11	10	9	8	7	6	5	4	3	2	1	0																																																																							
Cr.3	31	30	29	28	27	26	25	24	23	22	21	20	19	18	17	16																																																																							
Cr.4	47	46	45	44	43	42	41	40	39	38	37	36	35	34	33	32																																																																							
Cr.5	63	62	61	60	59	58	57	56	55	54	53	52	51	50	49	48																																																																							

(b) When failed ("Cr.0" is other than 0000H.)

Table 8.12 Values stored in "Cr" Command result area (When failed)

Cr	Command result area	Result details																																																																																					
	Cr.0	An error code is stored. (Hexadecimal)*1																																																																																					
	Cr.1	The executed command No. (8106H) is stored. (Hexadecimal)																																																																																					
	Cr.2	The command parameter setting status after writing is stored for each slice module.																																																																																					
	Cr.3																																																																																						
	Cr.4																																																																																						
	Cr.5																																																																																						
	Cr.5																																																																																						
		<table border="1"> <thead> <tr> <th></th> <th>b15</th> <th>b14</th> <th>b13</th> <th>b12</th> <th>b11</th> <th>b10</th> <th>b9</th> <th>b8</th> <th>b7</th> <th>b6</th> <th>b5</th> <th>b4</th> <th>b3</th> <th>b2</th> <th>b1</th> <th>b0</th> </tr> </thead> <tbody> <tr> <td>Cr.2</td> <td>15</td> <td>14</td> <td>13</td> <td>12</td> <td>11</td> <td>10</td> <td>9</td> <td>8</td> <td>7</td> <td>6</td> <td>5</td> <td>4</td> <td>3</td> <td>2</td> <td>1</td> <td>0</td> </tr> <tr> <td>Cr.3</td> <td>31</td> <td>30</td> <td>29</td> <td>28</td> <td>27</td> <td>26</td> <td>25</td> <td>24</td> <td>23</td> <td>22</td> <td>21</td> <td>20</td> <td>19</td> <td>18</td> <td>17</td> <td>16</td> </tr> <tr> <td>Cr.4</td> <td>47</td> <td>46</td> <td>45</td> <td>44</td> <td>43</td> <td>42</td> <td>41</td> <td>40</td> <td>39</td> <td>38</td> <td>37</td> <td>36</td> <td>35</td> <td>34</td> <td>33</td> <td>32</td> </tr> <tr> <td>Cr.5</td> <td>63</td> <td>62</td> <td>61</td> <td>60</td> <td>59</td> <td>58</td> <td>57</td> <td>56</td> <td>55</td> <td>54</td> <td>53</td> <td>52</td> <td>51</td> <td>50</td> <td>49</td> <td>48</td> </tr> </tbody> </table> <p>0: Parameters not set 1: Parameters set</p> <p>← Each bit indicates the corresponding slice position No.</p>		b15	b14	b13	b12	b11	b10	b9	b8	b7	b6	b5	b4	b3	b2	b1	b0	Cr.2	15	14	13	12	11	10	9	8	7	6	5	4	3	2	1	0	Cr.3	31	30	29	28	27	26	25	24	23	22	21	20	19	18	17	16	Cr.4	47	46	45	44	43	42	41	40	39	38	37	36	35	34	33	32	Cr.5	63	62	61	60	59	58	57	56	55	54	53	52	51	50	49	48
	b15	b14	b13	b12	b11	b10	b9	b8	b7	b6	b5	b4	b3	b2	b1	b0																																																																							
Cr.2	15	14	13	12	11	10	9	8	7	6	5	4	3	2	1	0																																																																							
Cr.3	31	30	29	28	27	26	25	24	23	22	21	20	19	18	17	16																																																																							
Cr.4	47	46	45	44	43	42	41	40	39	38	37	36	35	34	33	32																																																																							
Cr.5	63	62	61	60	59	58	57	56	55	54	53	52	51	50	49	48																																																																							

* 1 For details of error codes, refer to the following.

☞ MELSEC-ST CC-Link Head Module User's Manual, "9.7.2 Error code list"

POINT

- (1) In Cr.6 to Cr.19, intelligent function module's command parameter settings exceeding the quantity set in Cr.5 are not executed.
- (2) Initial data batch write request (Command No.: 8106H) cannot be executed with another command at the same time.
Doing so will cause an error.

8.3.2 Initial data individual write request (Command No.: 8107H/0107H)

Data size	
Cw	6 to 99 words (12 to 198 bytes)
Cr	4 to 35 words (8 to 70 bytes)

This command writes command parameters of the following modules to RAM for each module.

- Head module
- Input module
- Output module
- Intelligent function module

The input range setting is written to RAM of a single ST1AD.

(1) Values set to "Cw" Command execution area

Table 8.13 Values set to "Cw" Command execution area

Cw	Command execution area	Setting value
	Cw.0	Fixed to 0000H.
	Cw.1	Set a command No. to be executed (8107H/0107H). (Hexadecimal)
	Cw.2	Set the number of the command parameter settings for slice modules (number of the modules: 1 to 32). (Hexadecimal)
	Cw.3	[For execution of command No.8107H] Set a slice position No. of the target ST1AD. (Hexadecimal) [For execution of command No.0107H] Set a start slice No. of the target ST1AD. (Hexadecimal)
	Cw.4	Set a number specific to the ST1AD module. (Hexadecimal) •For the ST1AD2-V, set 8000H. •For the ST1AD2-I, set 8200H.
	Cw.5	Set respective command parameters for the ST1AD. (Hexadecimal) <div style="text-align: center;"> </div> <p>Fixed to 00H.</p> <ul style="list-style-type: none"> CH1 Input range setting (ST1AD2-V) <ul style="list-style-type: none"> 0H: -10 to 10V 1H: 0 to 10V 2H: 0 to 5V 3H: 1 to 5V 7H: User range setting CH1 Input range setting (ST1AD2-I) <ul style="list-style-type: none"> 0H: 4 to 20mA 1H: 0 to 20mA V 7H: User range setting CH2 Input range setting (ST1AD2-V) <ul style="list-style-type: none"> 0H: -10 to 10V 1H: 0 to 10V 2H: 0 to 5V 3H: 1 to 5V 7H: User range setting CH2 Input range setting (ST1AD2-I) <ul style="list-style-type: none"> 0H: 4 to 20mA 1H: 0 to 20mA 7H: User range setting

Table 8.13 Values set to "Cw" Command execution area (Continued)

Cw Command execution area	Setting value
Cw.6 to Cw.98	In the same way as in Cw.3 to Cw.5, set command parameters for each module.*1 (Three words each)

* 1 For settings of the head module and I/O modules, refer to the following.

➡ MELSEC-ST CC-Link Head Module User's Manual, "8.2.8 Initial data individual write request (Command No.: 8107H/0107H)"

For settings of intelligent function modules other than the ST1AD, refer to the following.

➡ Intelligent Function Module User's Manual, "Initial data individual write request (Command No.: 8107H/0107H)"

(2) Values stored in "Cr" Command result area

The command execution result data vary depending on the data (normal completion or failure) in Cr.0.

(a) When completed normally ("Cr.0" is 0000H.)

Table 8.14 Values stored in "Cr" Command result area (When completed normally)





Cr Command result area	Result details
Cr.0	Error code (0000H when completed normally)
Cr.1	The executed command No. (8107H/0107H) is stored. (Hexadecimal)
Cr.2	The number of command parameter settings of the intelligent function module is stored.
Cr.3	<p>[For execution of command No.8107H] The command execution result and slice position No. in hexadecimal are stored in the high and low bytes respectively as shown below.</p> <div style="text-align: center;"> </div>
	<p>[For execution of command No.0107H] The command execution result and start slice No. in hexadecimal are stored in the high and low bytes respectively as shown below.</p> <div style="text-align: center;"> </div>
Cr.4 to Cr.34	Detailed results for the intelligent function modules set in Cr.2 are stored in the same way as in Cr.3. (One word each)

(b) When failed ("Cr.0" is other than 0000H.)

Table 8.15 Values stored in "Cr" Command result area (When failed)

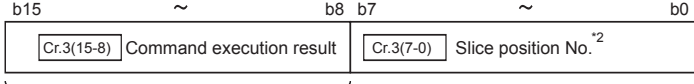
Cr Command result area	Result details
Cr.0	An error code is stored. (Hexadecimal)*1
Cr.1	The executed command No. (8107H/0107H) is stored. (Hexadecimal)
Cr.2	The number of command parameter settings of the intelligent function module is stored.

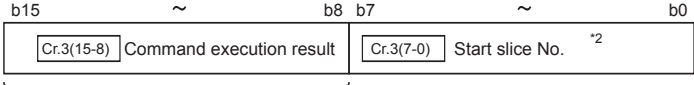
Table 8.15 Values stored in "Cr" Command result area (When failed) (Continued)

Cr	Command result area	Result details
Cr.3	<p>[For execution of command No.8107H] The command execution result and slice position No. in hexadecimal are stored in the high and low bytes respectively as shown below.</p> <div style="text-align: center;">  <p style="text-align: center;">Other than 00H: Failure ( 8.7 Values Stored into Command Execution Result)</p> </div> <p>[For execution of command No.0107H] The command execution result and start slice No. in hexadecimal are stored in the high and low bytes respectively as shown below.</p> <div style="text-align: center;">  <p style="text-align: center;">Other than 00H: Failure ( 8.7 Values Stored into Command Execution Result)</p> </div>	
Cr.4 to Cr.34	Detailed results for the intelligent function modules set in Cr.2 are stored in the same way as in Cr.3. (One word each)	

* 1 For details of error codes, refer to the following.

 MELSEC-ST CC-Link Head Module User's Manual, "9.7.2 Error code list"

* 2 When 0FH is stored in Cr.3(15-8) Command execution result, 00H (slice position No. or start slice No. of the head module) is stored in Cr.3(7-0) Slice position No. or start slice No.

POINT

- (1) Cw.3 to Cw.98, intelligent function module's command parameter settings exceeding the quantity set in Cw.2 are not executed.
- (2) Initial data individual write request (Command No.: 8107H/0107H) cannot be executed with another command at the same time.
Doing so will cause an error.
- (3) When the slice position No. or start slice No. is duplicated, the module with the duplicate setting is detected as an error module.

8.4 ST1AD Parameter Setting Read Commands

8.4.1 A/D conversion enable/disable setting read (Command No.: 9100H/1100H)

Data size	
Cw	4 words (8 bytes)
Cr	4 words (8 bytes)

This command reads the A/D conversion enable/disable setting from RAM of the ST1AD.

(1) Values set to "Cw" Command execution area

Table 8.16 Values set to "Cw" Command execution area

Cw Command execution area	Setting value
Cw.0	[For execution of command No.9100H] Set a slice position No. of the target ST1AD. (Hexadecimal)
Cw.1	[For execution of command No.1100H] Set a start slice No. of the target ST1AD. (Hexadecimal)
Cw.2	Set a command No. to be executed (9100H/1100H). (Hexadecimal)
Cw.3	Fixed to 0000H. (Any other value is treated as 0000H.)

(2) Values stored in "Cr" Command result area

The command execution result data vary depending on the result data (normal completion or failure) in Cr.0(15-8) Command execution result.

(a) When completed normally ("Cr.0(15-8)" Command execution result is 00H.)

Table 8.17 Values stored in "Cr" Command result area (When completed normally)

Cr Command result area	Result details
Cr.0	[For execution of command No.9100H] The command execution result and slice position No. in hexadecimal are stored in the high and low bytes respectively as shown below <div style="text-align: center;"> </div>
	[For execution of command No.1100H] The command execution result and start slice No. in hexadecimal are stored in the high and low bytes respectively as shown below. <div style="text-align: center;"> </div>
Cr.1	The executed command No. (9100H/1100H) is stored. (Hexadecimal)

Table 8.17 Values stored in "Cr" Command result area (When completed normally) (Continued)

Cr	Command result area	Result details
		The A/D conversion enable/disable setting in RAM is stored for each channel.
	Cr.2	<p>Fixed to 0.</p> <p>Fixed to 0.</p> <p>CH1: A/D conversion enable/disable setting 0: A/D conversion enable 1: A/D conversion disable</p> <p>CH2: A/D conversion enable/disable setting 0: A/D conversion enable 1: A/D conversion disable</p>
	Cr.3	0000H is stored.

(b) When failed ("Cr.0(15-8)" Command execution result is other than 00H.)

Table 8.18 Values stored in "Cr" Command result area (When failed)

Cr	Command result area	Result details
		[For execution of command No.9100H] The command execution result and slice position No. in hexadecimal are stored in the high and low bytes respectively as shown below
	Cr.0	<p>Other than 00H: Failure (☞ Section 8.7 Values Stored into Command Execution Result)</p>
		[For execution of command No.1100H] The command execution result and start slice No. in hexadecimal are stored in the high and low bytes respectively as shown below.
	Cr.0	<p>Other than 00H: Failure (☞ Section 8.7 Values Stored into Command Execution Result)</p>
	Cr.1	The executed command No. (9100H/1100H) is stored. (Hexadecimal)
	Cr.2	Cr.w.2 Argument 1 at command execution is stored.
	Cr.3	Cr.w.3 Argument 2 at command execution is stored.

* 1 When 0FH is stored in Cr.0(15-8) Command execution result, 00H (slice position No. or start slice No. of the head module) is stored in Cr.0(7-0) Slice position No. or start slice No.

8.4.2 A/D conversion channel read (Command No.: 9101H/1101H)

Data size	
Cw	4 words (8 bytes)
Cr	4 words (8 bytes)

This command reads current A/D conversion enable/disable setting and A/D conversion completion status.

(1) Values set to "Cw" Command execution area

Table 8.19 Values set to "Cw" Command execution area

Cw Command execution area	Setting value
Cw.0	[For execution of command No.9101H] Set a slice position No. of the target ST1AD. (Hexadecimal)
Cw.1	[For execution of command No.1101H] Set a start slice No. of the target ST1AD. (Hexadecimal)
Cw.2	Set a command No. to be executed (9101H/1101H). (Hexadecimal)
Cw.3	Fixed to 0000H. (Any other value is treated as 0000H.)

(2) Values stored in "Cr" Command result area

(a) When completed normally ("Cr.0(15-8)" Command execution result is 00H.)

Table 8.20 Values stored in "Cr" Command result area (When completed normally)

Cr Command result area	Setting value
Cr.0	<p>[For execution of command No.9101H] The command execution result and slice position No. in hexadecimal are stored in the high and low bytes respectively as shown below.</p> <div style="text-align: center;"> </div>
Cr.0	<p>[For execution of command No.1101H] The command execution result and start slice No. in hexadecimal are stored in the high and low bytes respectively as shown below.</p> <div style="text-align: center;"> </div>
Cr.1	The executed command No. (9101H/1101H) is stored. (Hexadecimal)

Table 8.20 Values stored in "Cr" Command result area (When completed normally) (Continued)

Cr	Command result area	Setting value
Cr.2		<p>The current A/D conversion enable/disable setting is stored for each channel.</p> <p>CH1: A/D conversion enable/disable setting 0: A/D conversion enable 1: A/D conversion disable</p> <p>CH2: A/D conversion enable/disable setting 0: A/D conversion enable 1: A/D conversion disable</p>
Cr.3		<p>The A/D conversion completion status is stored for each channel.</p> <p>CH1 A/D conversion completed status 0: A/D conversion being executed or not used 1: A/D conversion completed</p> <p>CH2 A/D conversion completed status 0: A/D conversion being executed or not used 1: A/D conversion completed</p>

(b) When failed ("Cr.0(15-8)" Command execution result is other than 00H.

Table 8.21 Values stored in "Cr" Command result area (When failed)

Cr	Command result area	Result details
Cr.0		<p>[For execution of command No.9101H] The command execution result and slice position No. in hexadecimal are stored in the high and low bytes respectively as shown below.</p> <p>Other than 00H: Failure (☞ Section 8.7 Values Stored into Command Execution Result:</p>
Cr.0		<p>[For execution of command No.1101H] The command execution result and start slice No. in hexadecimal are stored in the high and low bytes respectively as shown below.</p> <p>Other than 00H: Failure (☞ Section 8.7 Values Stored into Command Execution Result</p>
Cr.1		The executed command No. (9101H/1101H) is stored. (Hexadecimal)
Cr.2	Cr.w.2	Argument 1 at command execution is stored.
Cr.3	Cr.w.3	Argument 2 at command execution is stored.

* 1 When 0FH is stored in Cr.0(15-8) Command execution result, 00H (slice position No. or start slice No. of the head module) is stored in Cr.0(7-0) Slice position No. or start slice No.

8.4.3 Operation condition setting read (Command No.: 9102H/1102H)

Data size	
Cw	4 words (8 bytes)
Cr	4 words (8 bytes)

This command reads averaging process setting, alarm output setting, and disconnection detection setting from RAM of the ST1AD.

(1) Values set to "Cw" Command execution area

Table 8.22 Values set to "Cw" Command execution area

Cw	Command execution area	Setting value
Cw.0		[For execution of command No.9102H] Set a slice position No. of the target ST1AD. (Hexadecimal)
		[For execution of command No.1102H] Set a start slice No. of the target ST1AD. (Hexadecimal)
Cw.1		Set a command No. to be executed (9102H/1102H). (Hexadecimal)
Cw.2		Fixed to 0000H. (Any other value is treated as 0000H.)
Cw.3		

(2) Values stored in "Cr" Command result area

(a) When completed normally ("Cr.0(15-8)" Command execution result is 00H.)

Table 8.23 Values stored in "Cr" Command result area (When completed normally)

Cr	Command result area	Result details
Cr.0		[For execution of command No.9102H] The command execution result and slice position No. in hexadecimal are stored in the high and low bytes respectively as shown below. <div style="text-align: center;"> </div>
		[For execution of command No.1102H] The command execution result and start slice No. in hexadecimal are stored in the high and low bytes respectively as shown below. <div style="text-align: center;"> </div>
Cr.1		The executed command No. (9102H/1102H) is stored. (Hexadecimal)

Table 8.23 Values stored in "Cr" Command result area (When completed normally) (Continued)

Cr Command result area	Result details
<p>Cr.2</p>	<p>The averaging process setting is stored for each channel.</p> <p>Fixed to 0. Fixed to 0.</p> <p>0 0 H</p> <p>b3 b2 b1 b0</p> <p>0 0</p> <p>Fixed to 0.</p> <p>CH1 Time averaging/number of times averaging specification 0: Number of times averaging 1: Time averaging</p> <p>CH2 Time averaging/number of times averaging specification 0: Number of times averaging 1: Time averaging</p> <p>b11 b10 b9 b8</p> <p>0 0</p> <p>Fixed to 0.</p> <p>CH1 Sampling process/Averaging process setting 0: Sampling process 1: Averaging process</p> <p>CH2 Sampling process/Averaging process setting 0: Sampling process 1: Averaging process</p>
<p>Cr.3</p>	<p>The alarm output setting and disconnection detection setting are stored for each channel.</p> <p>Fixed to 0. Fixed to 0.</p> <p>0 0 H</p> <p>b3 b2 b1 b0</p> <p>0 0</p> <p>Fixed to 0.</p> <p>CH1 Alarm output setting 0: Alarm output not performed 1: Alarm output performed</p> <p>CH2 Alarm output setting 0: Alarm output not performed 1: Alarm output performed</p> <p>b11 b10 b9 b8</p> <p>0 0</p> <p>Fixed to 0.</p> <p>CH1 Disconnection detection setting 0: Disconnection detection not performed 1: Disconnection detection performed</p> <p>CH2 Disconnection detection setting 0: Disconnection detection not performed 1: Disconnection detection performed</p>

(b) When failed ("Cr.0(15-8)" Command execution result is other than 00H.)

Table 8.24 Values stored in "Cr" Command result area (When failed)

Cr	Command result area	Result details
Cr.0		<p>[For execution of command No.9102H] The command execution result and slice position No. in hexadecimal are stored in the high and low bytes respectively as shown below.</p> <div style="text-align: center;"> <p style="text-align: center;">Other than 00H: Failure (Section 8.7 Values Stored into Command Execution Result)</p> </div>
		<p>[For execution of command No.1102H] The command execution result and start slice No. in hexadecimal are stored in the high and low bytes respectively as shown below.</p> <div style="text-align: center;"> <p style="text-align: center;">Other than 00H: Failure (Section 8.7 Values Stored into Command Execution Result)</p> </div>
	Cr.1	The executed command No. (9102H/1102H) is stored. (Hexadecimal)
Cr.2	Cw.2	Argument 1 at command execution is stored.
Cr.3	Cw.3	Argument 2 at command execution is stored.

* 1 When 0FH is stored in Cr.0(15-8) Command execution result, 00H (slice position No. or start slice No. of the head module) is stored in Cr.0(7-0) Slice position No. or start slice No.

8.4.4 Notch filter setting read (Command No.: 9103H/1103H)

Data size	
Cw	4 words (8 bytes)
Cr	4 words (8 bytes)

This commands reads the notch filter setting from RAM of the ST1AD.

(1) Values set to "Cw" Command execution area

Table 8.25 Values set to "Cw" Command execution area

Cw	Command execution area	Setting value
Cw.0		[For execution of command No.9103H] Set a slice position No. of the target ST1AD. (Hexadecimal)
		[For execution of command No.1103H] Set a start slice No. of the target ST1AD. (Hexadecimal)
Cw.1		Set a command No. to be executed (9103H/1103H). (Hexadecimal)
Cw.2		Fixed to 0000H. (Any other value is treated as 0000H.)
Cw.3		

(2) Values stored in "Cr" Command result area

The command execution result data vary depending on the result data (normal completion or failure) in Cr.0(15-8) Command execution result.

(a) When completed normally ("Cr.0(15-8)" Command execution result is 00H.)

Table 8.26 Values stored in "Cr" Command result area (When completed normally)

Cr	Command result area	Result details
Cr.0		[For execution of command No.9103H] The command execution result and slice position No. in hexadecimal are stored in the high and low bytes respectively as shown below. <div style="text-align: center;"> <p style="text-align: center;">b15 ~ b8 b7 ~ b0</p> <p style="text-align: center;">Cr.0(15-8) Command execution result Cr.0(7-0) Slice position No.</p> <p style="text-align: center;">→ 00H: Normal completion</p> </div>
		[For execution of command No.1103H] The command execution result and start slice No. in hexadecimal are stored in the high and low bytes respectively as shown below. <div style="text-align: center;"> <p style="text-align: center;">b15 ~ b8 b7 ~ b0</p> <p style="text-align: center;">Cr.0(15-8) Command execution result Cr.0(7-0) Start slice No.</p> <p style="text-align: center;">→ 00H: Normal completion</p> </div>
Cr.1		The executed command No. (9103H/1103H) is stored. (Hexadecimal)
Cr.2		The notch filter setting is stored. (Hexadecimal) 0H: No notch filtering for all channels 1H: Notch filtering enabled for all channels (50 ± 3Hz) 2H: Notch filtering enabled for all channels (60 ± 3Hz)
Cr.3		0000H is stored.

(b) When failed ("Cr.0(15-8)" Command execution result is other than 00H.)

Table 8.27 Values stored in "Cr" Command result area (When failed)

Cr	Command result area	Result details
Cr.0	<p>[For execution of command No.9103H] The command execution result and slice position No. in hexadecimal are stored in the high and low bytes respectively as shown below.</p> <div style="text-align: center;"> <p style="text-align: center;">b15 ~ b8 b7 ~ b0</p> <p style="text-align: center;">Cr.0(15-8) Command execution result Cr.0(7-0) Slice position No. *1</p> <p style="text-align: center;">Other than 00H: Failure (Section 8.7 Values Stored into Command Execution Result)</p> </div>	
Cr.1	<p>[For execution of command No.1103H] The command execution result and start slice No. in hexadecimal are stored in the high and low bytes respectively as shown below.</p> <div style="text-align: center;"> <p style="text-align: center;">b15 ~ b8 b7 ~ b0</p> <p style="text-align: center;">Cr.0(15-8) Command execution result Cr.0(7-0) Start slice No. *1</p> <p style="text-align: center;">Other than 00H: Failure (Section 8.7 Values Stored into Command Execution Result)</p> </div>	
Cr.2	The executed command No. (9103H/1103H) is stored. (Hexadecimal)	
Cr.3	<p>Cw.2 Argument 1 at command execution is stored.</p> <p>Cw.3 Argument 2 at command execution is stored.</p>	

* 1 When 0FH is stored in Cr.0(15-8) Command execution result, 00H (slice position No. or start slice No. of the head module) is stored in Cr.0(7-0) Slice position No. or start slice No.

1	OVERVIEW
2	SYSTEM CONFIGURATION
3	SPECIFICATIONS
4	SETUP AND PROCEDURES BEFORE OPERATION
5	GX Configurator-ST
6	PROGRAMMING
7	ONLINE MODULE CHANGE
8	COMMANDS

8.4.5 CH [] time/count averaging setting read (Command No.: 9104H/1104H)

Data size	
Cw	4 words (8 bytes)
Cr	4 words (8 bytes)

This command reads the number of times or the period of time set for averaging process from RAM of the ST1AD.

(1) Values set to "Cw" Command execution area

Table 8.28 Values set to "Cw" Command execution area

Cw Command execution area	Setting value
Cw.0	[For execution of command No.9104H] Set a slice position No. of the target ST1AD. (Hexadecimal)
Cw.1	[For execution of command No.1104H] Set a start slice No. of the target ST1AD. (Hexadecimal)
Cw.2	Set a command No. to be executed (9104H/1104H). (Hexadecimal)
Cw.3	Fixed to 0000H. (Any other value is treated as 0000H.)

(2) Values stored in "Cr" Command result area

The command execution result data vary depending on the result data (normal completion or failure) in Cr.0(15-8) Command execution result.

(a) When completed normally ("Cr.0(15-8)" Command execution result is 00H.)

Table 8.29 Values stored in "Cr" Command result area (When completed normally)

Cr Command result area	Result details
Cr.0	<p>[For execution of command No.9104H] The command execution result and slice position No. in hexadecimal are stored in the high and low bytes respectively as shown below.</p> <div style="text-align: center;"> </div>
	<p>[For execution of command No.1104H] The command execution result and start slice No. in hexadecimal are stored in the high and low bytes respectively as shown below.</p> <div style="text-align: center;"> </div>
Cr.1	The executed command No. (9104H/1104H) is stored. (Hexadecimal)

Table 8.29 Values stored in "Cr" Command result area (When completed normally) (Continued)

Cr	Command result area	Result details
	Cr.2	The number of times or the period of time set for averaging process of channel 1 is stored. The value ranges are as follows: Count averaging: 4 to 62500 (times) Time averaging: 2 to 5000 (ms)
	Cr.3	The number of times or the period of time set for averaging process of channel 2 is stored. The value ranges are the same as Cr.2 response data 1.

(b) When failed ("Cr.0(15-8)" Command execution result is other than 00H.)

Table 8.30 Values stored in "Cr" Command result area (When failed)

Cr	Command result area	Result details
	Cr.0	<p>[For execution of command No.9104H] The command execution result and slice position No. in hexadecimal are stored in the high and low bytes respectively as shown below.</p> <div style="text-align: center;"> <p style="text-align: center;">b15 ~ b8 b7 ~ b0</p> <p style="text-align: center;">Cr.0(15-8) Command execution result Cr.0(7-0) Slice position No. *1</p> </div> <p style="text-align: center;">Other than 00H: Failure (☞ Section 8.7 Values Stored into Command Execution Result)</p>
	Cr.0	<p>[For execution of command No.1104H] The command execution result and start slice No. in hexadecimal are stored in the high and low bytes respectively as shown below.</p> <div style="text-align: center;"> <p style="text-align: center;">b15 ~ b8 b7 ~ b0</p> <p style="text-align: center;">Cr.0(15-8) Command execution result Cr.0(7-0) Start slice No. *1</p> </div> <p style="text-align: center;">Other than 00H: Failure (☞ Section 8.7 Values Stored into Command Execution Result)</p>
	Cr.1	The executed command No. (9104H/1104H) is stored. (Hexadecimal)
	Cr.2	Cw.2 Argument 1 at command execution is stored.
	Cr.3	Cw.3 Argument 2 at command execution is stored.

* 1 When 0FH is stored in Cr.0(15-8) Command execution result, 00H (slice position No. or start slice No. of the head module) is stored in Cr.0(7-0) Slice position No. or start slice No.

8.4.6 CH [] upper upper limit/upper lower limit setting read (Command No.: 9108H,910AH/1108H,110AH)

Data size	
Cw	4 words (8 bytes)
Cr	4 words (8 bytes)

This command reads the upper upper limit value or upper lower limit value set for alarm output from RAM of the ST1AD.

(1) Values set to "Cw" Command execution area

Table 8.31 Values set to "Cw" Command execution area

Cw	Command execution area	Setting value
Cw.0		[For execution of command No.9108H, 910AH] Set a slice position No. of the target ST1AD. (Hexadecimal) [For execution of command No.1108H, 110AH] Set a start slice No. of the target ST1AD. (Hexadecimal)
Cw.1		Set a command No. to be executed. (Hexadecimal) CH1 upper upper limit/upper lower limit setting read: 9108H, 1108H CH2 upper upper limit/upper lower limit setting read: 910AH, 110AH
Cw.2		Fixed to 0000H. (Any other value is treated as 0000H.)
Cw.3		

(2) Values stored in "Cr" Command result area

The command execution result data vary depending on the result data (normal completion or failure) in Cr.0(15-8) Command execution result.

(a) When completed normally ("Cr.0(15-8)" Command execution result is 00H.)

Table 8.32 Values stored in "Cr" Command result area (When completed normally)

Cr	Command result area	Result details
Cr.0		[For execution of command No.9108H, 910AH] The command execution result and slice position No. in hexadecimal are stored in the high and low bytes respectively as shown below. <div style="text-align: center;"> </div>
Cr.0		[For execution of command No.1108H, 110AH] The command execution result and start slice No. in hexadecimal are stored in the high and low bytes respectively as shown below. <div style="text-align: center;"> </div>
Cr.1		The executed command No. (9108H/1108H, 910AH/110AH) is stored. (Hexadecimal)

Table 8.32 Values stored in "Cr" Command result area (When completed normally) (Continued)

Cr	Command result area	Result details
	Cr.2	CH □ upper upper limit value is stored. (16-bit signed binary) The value ranges are as follows: ST1AD2-V: -4096 to 4095 ST1AD2-I: -96 to 4095
	Cr.3	CH □ upper lower limit value is stored. (16-bit signed binary) The value ranges are as follows: ST1AD2-V: -4096 to 4095 ST1AD2-I: -96 to 4095

(b) When failed ("Cr.0(15-8)" Command execution result is other than 00H.)

Table 8.33 Values stored in "Cr" Command result area (When failed)

Cr	Command result area	Result details
	Cr.0	<p>[For execution of command No.9108H, 910AH] The command execution result and slice position No. in hexadecimal are stored in the high and low bytes respectively as shown below.</p> <div style="text-align: center;"> <p style="text-align: center;"> Cr.0(15-8) Command execution result Cr.0(7-0) Slice position No. *1 </p> <p style="text-align: center;"> ↳ Other than 00H: Failure (↳ Section 8.7 Values Stored into Command Execution Result) </p> </div> <hr/> <p>[For execution of command No.1108H, 110AH] The command execution result and start slice No. in hexadecimal are stored in the high and low bytes respectively as shown below.</p> <div style="text-align: center;"> <p style="text-align: center;"> Cr.0(15-8) Command execution result Cr.0(7-0) Start slice No. *1 </p> <p style="text-align: center;"> ↳ Other than 00H: Failure (↳ Section 8.7 Values Stored into Command Execution Result) </p> </div>
	Cr.1	The executed command No. (9108H/1108H, 910AH/110AH) is stored. (Hexadecimal)
	Cr.2	Cw.2 Argument 1 at command execution is stored.
	Cr.3	Cw.3 Argument 2 at command execution is stored.

* 1 When 0FH is stored in Cr.0(15-8) Command execution result, 00H (slice position No. or start slice No. of the head module) is stored in Cr.0(7-0) Slice position No. or start slice No.

8.4.7 CH [] lower upper limit/lower lower limit setting read (Command No.: 9109H, 910BH/1109H, 110BH)

Data size	
Cw	4 words (8 bytes)
Cr	4 words (8 bytes)

This command reads the lower upper limit value or lower lower limit value set for alarm output from RAM of the ST1AD.

(1) Values set to "Cw" Command execution area

Table 8.34 Values set to "Cw" Command execution area

Cw Command execution area	Setting value
Cw.0	[For execution of command No.9109H, 910BH] Set a slice position No. of the target ST1AD. (Hexadecimal) [For execution of command No.1109H, 110BH] Set a start slice No. of the target ST1AD. (Hexadecimal)
Cw.1	Set a command No. to be executed. (Hexadecimal) CH1 lower upper limit/lower lower limit setting read: 9109H, 1109H CH2 lower upper limit/lower lower limit setting read: 910BH, 110BH
Cw.2	Fixed to 0000H. (Any other value is treated as 0000H.)
Cw.3	

(2) Values stored in "Cr" Command result area

The command execution result data vary depending on the result data (normal completion or failure) in Cr.0(15-8) Command execution result.

(a) When completed normally ("Cr.0(15-8)" Command execution result is 00H.)

Table 8.35 Values stored in "Cr" Command result area (When completed normally)



Cr Command result area	Result details
Cr.0	[For execution of command No.9109H, 910BH] The command execution result and slice position No. in hexadecimal are stored in the high and low bytes respectively as shown below. 
	[For execution of command No.1109H, 110BH] The command execution result and start slice No. in hexadecimal are stored in the high and low bytes respectively as shown below. 
Cr.1	The executed command No. (9109H/1109H, 910BH/110BH) is stored. (Hexadecimal)

Table 8.35 Values stored in "Cr" Command result area (When completed normally) (Continued)

Cr	Command result area	Result details
	Cr.2	CH □ lower upper limit value is stored. (16-bit signed binary) The value ranges are as follows: ST1AD2-V: -4096 to 4095 ST1AD2-I: -96 to 4095
	Cr.3	CH □ lower lower limit value is stored. (16-bit signed binary) The value ranges are as follows: ST1AD2-V: -4096 to 4095 ST1AD2-I: -96 to 4095

(b) When failed ("Cr.0(15-8)" Command execution result is other than 00H.)

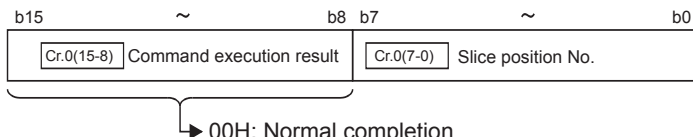
Table 8.36 Values stored in "Cr" Command result area (When failed)

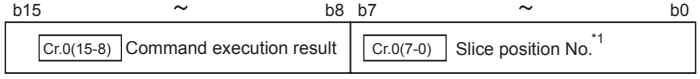
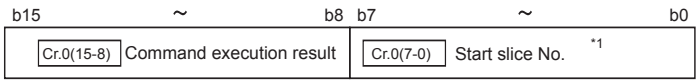
Cr	Command result area	Result details
	Cr.0	<p>[For execution of command No.9109H, 910BH] The command execution result and slice position No. in hexadecimal are stored in the high and low bytes respectively as shown below.</p>  <p>Other than 00H: Failure (☞ Section 8.7 Values Stored into Command Execution Result)</p> <p>[For execution of command No.1109H, 110BH] The command execution result and start slice No. in hexadecimal are stored in the high and low bytes respectively as shown below.</p>  <p>Other than 00H: Failure (☞ Section 8.7 Values Stored into Command Execution Result)</p>
	Cr.1	The executed command No. (9109H/1109H, 910BH/110BH) is stored. (Hexadecimal)
	Cr.2	Cw.2 Argument 1 at command execution is stored.
	Cr.3	Cw.3 Argument 2 at command execution is stored.

* 1 When 0FH is stored in Cr.0(15-8) Command execution result, 00H (slice position No. or start slice No. of the head module) is stored in Cr.0(7-0) Slice position No. or start slice No.

8.4.8 Input range setting read (Command No.: 9118H/1118H)

Data size	
<input type="checkbox"/> Cw	4 words (8 bytes)
<input type="checkbox"/> Cr	4 words (8 bytes)

This command reads the input range setting from RAM of the ST1AD.

(1) Values set to "Cw" Command execution area

Table 8.37 Values set to "Cw" Command execution area

<input type="checkbox"/> Cw Command execution area	Setting value
<input type="checkbox"/> Cw.0	[For execution of command No.9118H] Set a slice position No. of the target ST1AD. (Hexadecimal)
	[For execution of command No.1118H] Set a start slice No. of the target ST1AD. (Hexadecimal)
<input type="checkbox"/> Cw.1	Set a command No. to be executed (9118H/1118H). (Hexadecimal)
<input type="checkbox"/> Cw.2	Fixed to 0000H. (Any other value is treated as 0000H.)
<input type="checkbox"/> Cw.3	

(2) Values stored in "Cr" Command result area

The command execution result data vary depending on the result data (normal completion or failure) in Cr.0(15-8) Command execution result.

(a) When completed normally ("Cr.0(15-8)" Command execution result is 00H.)

Table 8.38 Values stored in "Cr" Command result area (When completed normally)

<input type="checkbox"/> Cr Command result area	Result details
<input type="checkbox"/> Cr.0	[For execution of command No.9118H] The command execution result and slice position No. in hexadecimal are stored in the high and low bytes respectively as shown below. <div style="text-align: center;"> </div>
	[For execution of command No.1118H] The command execution result and start slice No. in hexadecimal are stored in the high and low bytes respectively as shown below. <div style="text-align: center;"> </div>
<input type="checkbox"/> Cr.1	The executed command No. (9118H/1118H) is stored. (Hexadecimal)

Table 8.38 Values stored in "Cr" Command result area (When completed normally) (Continued)

Cr	Command result area	Result details
		The input range setting written to RAM is stored for each channel.
	Cr.2 *1	<p>Fixed to 00H.</p> <p>CH1 Input range setting (ST1AD2-V) 0H: -10 to 10V 1H: 0 to 10V 2H: 0 to 5V 3H: 1 to 5V 7H: User range setting</p> <p>CH1 Input range setting (ST1AD2-I) 0H: 4 to 20mA 1H: 0 to 20mA 7H: User range setting</p> <p>CH2 Input range setting (ST1AD2-V) 0H: -10 to 10V 1H: 0 to 10V 2H: 0 to 5V 3H: 1 to 5V 7H: User range setting</p> <p>CH2 Input range setting (ST1AD2-I) 0H: 4 to 20mA 1H: 0 to 20mA 7H: User range setting</p>
	Cr.3 *1	The current input range setting is stored for each channel. The stored value is the same as Cr.2 response data 1.

* 1 If the stored values differ between Cr.2 and Cr.3, the parameters written to the RAM with the command have not taken effect in the module. Set Bw.n+1 Convert setting request to ON (1) for the parameters on the RAM to take effect in the module.

(b) When failed ("Cr.0(15-8)" Command execution result is other than 00H.)

Table 8.39 Values stored in "Cr" Command result area (When failed)

Cr	Command result area	Result details
	Cr.0	<p>[For execution of command No.9118H]</p> <p>The command execution result and slice position No. in hexadecimal are stored in the high and low bytes respectively as shown below.</p> <p>Other than 00H: Failure (☞ Section 8.7 Values Stored into Command Execution Result)</p>
	Cr.0	<p>[For execution of command No.1118H]</p> <p>The command execution result and start slice No. in hexadecimal are stored in the high and low bytes respectively as shown below.</p> <p>Other than 00H: Failure (☞ Section 8.7 Values Stored into Command Execution Result)</p>
	Cr.1	The executed command No. (9118H/1118H) is stored. (Hexadecimal)

Table 8.39 Values stored in "Cr" Command result area (When failed) (Continued)

Cr	Command result area	Result details
	Cr.2	Cw.2 Argument 1 at command execution is stored.
	Cr.3	Cw.3 Argument 2 at command execution is stored.

* 1 When 0FH is stored in Command execution result, 00H (slice position No. or start slice No. of the head module) is stored in Slice position No. or start slice No.

8.5 ST1AD Parameter Setting Write Commands

8.5.1 A/D conversion enable/disable setting write (Command No.: A100H/2100H)

Data size	
Cw	4 words (8 bytes)
Cr	4 words (8 bytes)

This command writes the A/D conversion enable/disable setting to RAM of the ST1AD, and can be executed only in normal mode and when Bw.n+1 Convert setting request is off (0).

(1) Values set to "Cw" Command execution area

Table 8.40 Values set to "Cw" Command execution area

Cw Command execution area	Setting value
Cw.0	[For execution of command No.A100H] Set a slice position No. of the target ST1AD. (Hexadecimal) [For execution of command No.2100H] Set a start slice No. of the target ST1AD. (Hexadecimal)
Cw.1	Set a command No. to be executed (A100H/2100H). (Hexadecimal)
Cw.2	Set an A/D conversion enable/disable setting for each channel.
Cw.3	Fixed to 0000H. (Any other value is treated as 0000H.)

(2) Values stored in "Cr" Command result area

The command execution result data vary depending on the result data (normal completion or failure) in $\boxed{\text{Cr.0(15-8)}}$ Command execution result.

(a) When completed normally ("Cr.0(15-8)" Command execution result is 00H.)

Table 8.41 Values stored in "Cr" Command result area (When completed normally)

$\boxed{\text{Cr}}$ Command result area	Result details
$\boxed{\text{Cr.0}}$	<p>[For execution of command No.A100H] The command execution result and slice position No. in hexadecimal are stored in the high and low bytes respectively as shown below.</p> <div style="text-align: center;"> </div>
	<p>[For execution of command No.2100H] The command execution result and start slice No. in hexadecimal are stored in the high and low bytes respectively as shown below.</p> <div style="text-align: center;"> </div>
$\boxed{\text{Cr.1}}$	The executed command No. (A100H/2100H) is stored. (Hexadecimal)
$\boxed{\text{Cr.2}}$	$\boxed{\text{Cw.2}}$ Argument 1 at command execution is stored.
$\boxed{\text{Cr.3}}$	0000H is stored.

(b) When failed ("Cr.0(15-8)" Command execution result is other than 00H.)

Table 8.42 Values stored in "Cr" Command result area (When failed)

$\boxed{\text{Cr}}$ Command result area	Result details
$\boxed{\text{Cr.0}}$	<p>[For execution of command No.A100H] The command execution result and slice position No. in hexadecimal are stored in the high and low bytes respectively as shown below.</p> <div style="text-align: center;"> </div>
	<p>[For execution of command No.2100H] The command execution result and start slice No. in hexadecimal are stored in the high and low bytes respectively as shown below.</p> <div style="text-align: center;"> </div>

Table 8.42 Values stored in "Cr" Command result area (When failed)

Cr	Command result area	Result details
	Cr.1	The executed command No. (A100H/2100H) is stored. (Hexadecimal)
	Cr.2	Cw.2 Argument 1 at command execution is stored.
	Cr.3	Cw.3 Argument 2 at command execution is stored.

* 1 When 0FH is stored in Cr.0(15-8) Command execution result, 00H (slice position No. or start slice No. of the head module) is stored in Cr.0(7-0) Slice position No. or start slice No.

1

OVERVIEW

2

SYSTEM
CONFIGURATION

3

SPECIFICATIONS

4

SETUP AND
PROCEDURES BEFORE
OPERATION

5

GX Configurator-ST

6

PROGRAMMING

7

ONLINE MODULE
CHANGE

8

COMMANDS

8.5.2 Operating condition setting write (Command No.: A102H/2102H)

Data size	
Cw	4 words (8 bytes)
Cr	4 words (8 bytes)

This command writes the averaging process setting, alarm output setting, and disconnection detection setting to RAM of the ST1AD, and can be executed only in normal mode and when Bw.n+1 Convert setting request is OFF (0).

(1) Values set to "Cw" Command execution area

Table 8.43 Values set to "Cw" Command execution area

<input type="checkbox"/> Cw Command execution area	Setting value
<input type="checkbox"/> Cw.0	<p>[For execution of command No.A102H] Set a slice position No. of the target ST1AD. (Hexadecimal)</p> <p>[For execution of command No.2102H] Set a start slice No. of the target ST1AD. (Hexadecimal)</p>
<input type="checkbox"/> Cw.1	Set a command No. to be executed (A102H/2102H). (Hexadecimal)
<input type="checkbox"/> Cw.2	<p>Specify sampling or averaging process for each channel. For sampling process, specify time or count averaging. Fixed to 0. Fixed to 0.</p> <p>CH1 Time averaging/number of times averaging specification 0: Number of times averaging 1: Time averaging</p> <p>CH2 Time averaging/number of times averaging specification 0: Number of times averaging 1: Time averaging</p> <p>CH1 Sampling process/Averaging process setting 0: Sampling process 1: Averaging process</p> <p>CH2 Sampling process/Averaging process setting 0: Sampling process 1: Averaging process</p>

Table 8.43 Values set to "Cw" Command execution area

Cw Command execution area	Setting value
Cw.3	<p>Specify the channel(s) for which alarm output and/or disconnection detection is to be performed.</p> <p>Fixed to 0. Fixed to 0.</p> <p>CH1 Alarm output setting 0: Alarm output not performed 1: Alarm output performed</p> <p>CH2 Alarm output setting 0: Alarm output not performed 1: Alarm output performed</p> <p>CH1 Disconnection detection setting 0: Disconnection detection not performed 1: Disconnection detection performed</p> <p>CH2 Disconnection detection setting 0: Disconnection detection not performed 1: Disconnection detection performed</p>

(2) Values stored in "Cr" Command result area

The command execution result data vary depending on the result data (normal completion or failure) in [Cr.0(15-8)] Command execution result.

(a) When completed normally ("Cr.0(15-8)" Command execution result is 00H.)

Table 8.44 Values stored in "Cr" Command result area (When completed normally)

Cr Command result area	Result details
Cr.0	<p>[For execution of command No.A102H] The command execution result and slice position No. in hexadecimal are stored in the high and low bytes respectively as shown below.</p> <p>00H: Normal completion</p>
Cr.0	<p>[For execution of command No.2102H] The command execution result and start slice No. in hexadecimal are stored in the high and low bytes respectively as shown below.</p> <p>00H: Normal completion</p>
Cr.1	The executed command No. (A102H/2102H) is stored. (Hexadecimal)

Table 8.44 Values stored in "Cr" Command result area (When completed normally)

Cr Command result area	Result details
Cr.2	0000H is stored.
Cr.3	

(b) When failed ("Cr.0(15-8)" Command execution result is other than 00H.)

Table 8.45 Values stored in "Cr" Command result area (When failed)

Cr Command result area	Result details
Cr.0	<p>[For execution of command No.A102H] The command execution result and slice position No. in hexadecimal are stored in the high and low bytes respectively as shown below.</p> <div style="text-align: center;"> <p style="text-align: center;">b15 ~ b8 b7 ~ b0</p> <p style="text-align: center;">Cr.0(15-8) Command execution result Cr.0(7-0) Slice position No. *1</p> <p style="text-align: center;">→ Other than 00H: Failure (Section 8.7 Values Stored into Command Execution Result)</p> </div> <hr/> <p>[For execution of command No.2102H] The command execution result and start slice No. in hexadecimal are stored in the high and low bytes respectively as shown below.</p> <div style="text-align: center;"> <p style="text-align: center;">b15 ~ b8 b7 ~ b0</p> <p style="text-align: center;">Cr.0(15-8) Command execution result Cr.0(7-0) Start slice No. *1</p> <p style="text-align: center;">→ Other than 00H: Failure (Section 8.7 Values Stored into Command Execution Result)</p> </div>
Cr.1	The executed command No. (A102H/2102H) is stored. (Hexadecimal)
Cr.2	Cw.2 Argument 1 at command execution is stored.
Cr.3	Cw.3 Argument 2 at command execution is stored.

* 1 When 0FH is stored in Cr.0(15-8) Command execution result, 00H (slice position No. or start slice No. of the head module) is stored in Cr.0(7-0) Slice position No. or start slice No.

8.5.3 Notch filter setting write (Command No.: A103H/2103H)

Data size	
Cw	4 words (8 bytes)
Cr	4 words (8 bytes)

This command writes the notch filter setting to RAM of the ST1AD, and can be executed only in normal mode and when Bw.n+1 Convert setting request is OFF (0).

(1) Values set to "Cw" Command execution area

Table 8.46 Values set to "Cw" Command execution area

<input type="checkbox"/> Cw Command execution area	Setting value
<input type="checkbox"/> Cw.0	[For execution of command No.A103H] Set a slice position No. of the target ST1AD. (Hexadecimal)
	[For execution of command No.2103H] Set a start slice No. of the target ST1AD. (Hexadecimal)
<input type="checkbox"/> Cw.1	Set a command No. to be executed (A103H/2103H). (Hexadecimal)
<input type="checkbox"/> Cw.2	Set a value for notch filtering. 0: No notch filtering for all channels 1: Notch filtering enabled for all channels (50 ± 3Hz) 2: Notch filtering enabled for all channels (60 ± 3Hz)
<input type="checkbox"/> Cw.3	Fixed to 0000H. (Any other value is treated as 0000H.)

(2) Values stored in "Cr" Command result area

The command execution result data vary depending on the result data (normal completion or failure) in Cr.0(15-8) Command execution result.

(a) When completed normally ("Cr.0(15-8)" Command execution result is 00H.)

Table 8.47 Values stored in "Cr" Command result area (When completed normally)

Cr Command result area	Result details
Cr.0	<p>[For execution of command No.A103H] The command execution result and slice position No. in hexadecimal are stored in the high and low bytes respectively as shown below.</p>
	<p>[For execution of command No.2103H] The command execution result and start slice No. in hexadecimal are stored in the high and low bytes respectively as shown below.</p>
Cr.1	The executed command No. (A103H/2103H) is stored. (Hexadecimal)
Cr.2	Cr.2 Argument 1 at command execution is stored.
Cr.3	0000H is stored.

(b) When failed ("Cr.0(15-8)" Command execution result is other than 00H.)

Table 8.48 Values stored in "Cr" Command result area (When failed)

Cr Command result area	Result details
Cr.0	<p>[For execution of command No.A103H] The command execution result and slice position No. in hexadecimal are stored in the high and low bytes respectively as shown below.</p>
	<p>[For execution of command No.2103H] The command execution result and start slice No. in hexadecimal are stored in the high and low bytes respectively as shown below.</p>

Table 8.48 Values stored in "Cr" Command result area (When failed)

Cr	Command result area	Result details
	Cr.1	The executed command No. (A103H/2103H) is stored. (Hexadecimal)
	Cr.2	Cw.2 Argument 1 at command execution is stored.
	Cr.3	Cw.3 Argument 2 at command execution is stored.

* 1 When 0FH is stored in Cr.0(15-8) Command execution result, 00H (slice position No. or start slice No. of the head module) is stored in Cr.0(7-0) Slice position No. or start slice No.

8.5.4 CH [] time/count averaging setting write (Command No.: A104H/2104H)

Data size	
<input type="text" value="Cw"/>	4 words (8 bytes)
<input type="text" value="Cr"/>	4 words (8 bytes)

This command writes the number of times or period of time set for averaging process to RAM of the ST1AD, and can be executed only in normal mode and when Convert setting request is OFF (0).

(1) Values set to "Cw" Command execution area

Table 8.49 Values set to "Cw" Command execution area

<input type="text" value="Cw"/> Command execution area	Setting value
<input type="text" value="Cw.0"/>	[For execution of command No.A104H] Set a slice position No. of the target ST1AD. (Hexadecimal)
	[For execution of command No.2104H] Set a start slice No. of the target ST1AD. (Hexadecimal)
<input type="text" value="Cw.1"/>	Set a command No. to be executed (A104H/2104H). (Hexadecimal)
<input type="text" value="Cw.2"/>	Set the number of times or the period of time set for averaging process of channel 1. The setting ranges are as follows: Count averaging: 4 to 62500 (times) Time averaging: 2 to 5000 (ms)
<input type="text" value="Cw.3"/>	Set the number of times or the period of time set for averaging process of channel 2. The setting range is the same as <input type="text" value="Cw.2"/> Argument 1.

(2) Values stored in "Cr" Command result area

The command execution result data vary depending on the result data (normal completion or failure) in $\boxed{\text{Cr.0(15-8)}}$ Command execution result.

(a) When completed normally ("Cr.0(15-8)" Command execution result is 00H.)

Table 8.50 Values stored in "Cr" Command result area (When completed normally)

Cr	Command result area	Result details
$\boxed{\text{Cr.0}}$		<p>[For execution of command No.A104H] The command execution result and slice position No. in hexadecimal are stored in the high and low bytes respectively as shown below.</p> <div style="text-align: center;"> </div>
		<p>[For execution of command No.2104H] The command execution result and start slice No. in hexadecimal are stored in the high and low bytes respectively as shown below.</p> <div style="text-align: center;"> </div>
	$\boxed{\text{Cr.1}}$	The executed command No. (A104H/2104H) is stored. (Hexadecimal)
	$\boxed{\text{Cr.2}}$	0000H is stored.
	$\boxed{\text{Cr.3}}$	

(b) When failed ("Cr.0(15-8)" Command execution result is other than 00H.)

Table 8.51 Values stored in "Cr" Command result area (When failed)

Cr	Command result area	Result details
$\boxed{\text{Cr.0}}$		<p>[For execution of command No.A104H] The command execution result and slice position No. in hexadecimal are stored in the high and low bytes respectively as shown below.</p> <div style="text-align: center;"> </div>
		<p>[For execution of command No.2104H] The command execution result and start slice No. in hexadecimal are stored in the high and low bytes respectively as shown below.</p> <div style="text-align: center;"> </div>

Table 8.51 Values stored in "Cr" Command result area (When failed)

Cr Command result area	Result details
Cr.1	The executed command No. (A104H/2104H) is stored. (Hexadecimal)
Cr.2	Cw.2 Argument 1 at command execution is stored.
Cr.3	Cw.3 Argument 2 at command execution is stored.

* 1 When 0FH is stored in Cr.0(15-8) Command execution result, 00H (slice position No. or start slice No. of the head module) is stored in Cr.0(7-0) Slice position No. or start slice No.

8.5.5 CH [] upper upper limit/upper lower limit setting write (Command No.: A108H, A10AH/2108H,210AH)

Data size	
<input type="checkbox"/> Cw	4 words (8 bytes)
<input type="checkbox"/> Cr	4 words (8 bytes)

This command writes the upper upper limit value and upper lower limit value for alarm output to RAM of the ST1AD, and can be executed only in normal mode and when

Bw.n+1 Convert setting request is OFF (0).

(1) Values set to "Cw" Command execution area

Table 8.52 Values set to "Cw" Command execution area

<input type="checkbox"/> Cw Command execution area	Setting value
<input type="checkbox"/> Cw.0	[For execution of command No.A108H, A10AH] Set a slice position No. of the target ST1AD. (Hexadecimal) [For execution of command No.2108H, 210AH] Set a start slice No. of the target ST1AD. (Hexadecimal)
<input type="checkbox"/> Cw.1	Set a command No. to be executed. (Hexadecimal) CH1 upper upper limit/upper lower limit setting write: A108H, 2108H CH2 upper upper limit/upper lower limit setting write: A10AH, 210AH
<input type="checkbox"/> Cw.2	Set an upper upper limit value for alarm output. The setting ranges are as follows: ST1AD2-V: - 4096 to 4095 ST1AD2-I: - 96 to 4095 The condition, Upper upper limit value \geq Upper lower limit value \geq Lower upper limit value \geq Lower lower limit value, must be met.
<input type="checkbox"/> Cw.3	Set an upper lower limit value for alarm output. The setting range is the same as <input type="checkbox"/> Cw.2 Argument 1.

(2) Values stored in "Cr" Command result area

The command execution result data vary depending on the result data (normal completion or failure) in Cr.0(15-8) Command execution result.

(a) When completed normally ("Cr.0(15-8)" Command execution result is 00H.)

Table 8.53 Values stored in "Cr" Command result area (When completed normally)

Cr Command result area	Result details
Cr.0	<p>[For execution of command No.A108H, A10AH] The command execution result and slice position No. in hexadecimal are stored in the high and low bytes respectively as shown below.</p> <div style="text-align: center;"> <p style="text-align: center;">→ 00H: Normal completion</p> </div>
	<p>[For execution of command No.2108H, 210AH] The command execution result and start slice No. in hexadecimal are stored in the high and low bytes respectively as shown below.</p> <div style="text-align: center;"> <p style="text-align: center;">→ 00H: Normal completion</p> </div>
Cr.1	The executed command No. (A108H/2108H, A10AH/210AH) is stored. (Hexadecimal)
Cr.2	0000H is stored.
Cr.3	

(b) When failed ("Cr.0(15-8)" Command execution result is other than 00H.)

Table 8.54 Values stored in "Cr" Command result area (When failed)

Cr Command result area	Result details
Cr.0	<p>[For execution of command No.A108H, A10AH] The command execution result and slice position No. in hexadecimal are stored in the high and low bytes respectively as shown below.</p> <div style="text-align: center;"> <p style="text-align: center;">→ Other than 00H: Failure (☞ Section 8.7 Values Stored into Command Execution Result)</p> </div>
	<p>[For execution of command No.2108H, 210AH] The command execution result and start slice No. in hexadecimal are stored in the high and low bytes respectively as shown below.</p> <div style="text-align: center;"> <p style="text-align: center;">→ Other than 00H: Failure (☞ Section 8.7 Values Stored into Command Execution Result)</p> </div>

Table 8.54 Values stored in "Cr" Command result area (When failed)

Cr Command result area	Result details
Cr.1	The executed command No. (A108H/2108H, A10AH/210AH) is stored. (Hexadecimal)
Cr.2	Cw.2 Argument 1 at command execution is stored.
Cr.3	Cw.3 Argument 2 at command execution is stored.

* 1 When 0FH is stored in Cr.0(15-8) Command execution result, 00H (slice position No. or start slice No. of the head module) is stored in Cr.0(7-0) Slice position No. or start slice No.

1

OVERVIEW

2

SYSTEM CONFIGURATION

3

SPECIFICATIONS

4

SETUP AND PROCEDURES BEFORE OPERATION

5

GX Configurator-ST

6

PROGRAMMING

7

ONLINE MODULE CHANGE

8

COMMANDS

8.5.6 CH [] lower upper limit/lower lower limit setting write (Command No.: A109H, A10BH/2109H, 210BH)

Data size	
<input type="checkbox"/> Cw	4 words (8 bytes)
<input type="checkbox"/> Cr	4 words (8 bytes)

This command writes the lower upper limit value and lower lower limit value for alarm output to RAM of the ST1AD, and can be executed only in normal mode and when

Bw.n+1 Convert setting request is OFF (0).

(1) Values set to "Cw" Command execution area

Table 8.55 Values set to "Cw" Command execution area

<input type="checkbox"/> Cw Command execution area	Setting value
<input type="checkbox"/> Cw.0	[For execution of command No.A109H, A10BH] Set a slice position No. of the target ST1AD. (Hexadecimal) [For execution of command No.2109H, 210BH] Set a start slice No. of the target ST1AD. (Hexadecimal)
<input type="checkbox"/> Cw.1	Set a command No. to be executed. (Hexadecimal) CH1 lower upper limit/lower lower limit setting write: A109H, 2109H CH2 lower upper limit/lower lower limit setting write: A10BH, 210BH
<input type="checkbox"/> Cw.2	Set a lower upper limit value for alarm output. The setting ranges are as follows: ST1AD2-V: - 4096 to 4095 ST1AD2-I: - 96 to 4095 The condition, Upper upper limit value \geq Upper lower limit value \geq Lower upper limit value \geq Lower lower limit value, must be met.
<input type="checkbox"/> Cw.3	Set an upper lower limit value for alarm output. The setting range is the same as <input type="checkbox"/> Cw.2 Argument 1.

(2) Values stored in "Cr" Command result area

The command execution result data vary depending on the result data (normal completion or failure) in Cr.0(15-8) Command execution result.

(a) When completed normally ("Cr.0(15-8)" Command execution result is 00H.)

Table 8.56 Values stored in "Cr" Command result area (When completed normally)

Cr Command result area	Result details
Cr.0	<p>[For execution of command No.A109H, A10BH] The command execution result and slice position No. in hexadecimal are stored in the high and low bytes respectively as shown below.</p> <p>00H: Normal completion</p>
	<p>[For execution of command No.2109H, 210BH] The command execution result and start slice No. in hexadecimal are stored in the high and low bytes respectively as shown below.</p> <p>00H: Normal completion</p>
Cr.1	The executed command No. (A109H/2109H, A10BH/210BH) is stored. (Hexadecimal)
Cr.2	0000H is stored.
Cr.3	

(b) When failed ("Cr.0(15-8)" Command execution result is other than 00H.)

Table 8.57 Values stored in "Cr" Command result area (When failed)

Cr Command result area	Result details
Cr.0	<p>[For execution of command No.A109H, A10BH] The command execution result and slice position No. in hexadecimal are stored in the high and low bytes respectively as shown below.</p> <p>Other than 00H: Failure (Section 8.7 Values Stored into Command Execution Result)</p>
	<p>[For execution of command No.2109H, 210BH] The command execution result and start slice No. in hexadecimal are stored in the high and low bytes respectively as shown below.</p> <p>Other than 00H: Failure (Section 8.7 Values Stored into Command Execution Result)</p>

Table 8.57 Values stored in "Cr" Command result area (When failed) (Continued)

Cr Command result area	Result details
Cr.1	The executed command No. (A109H/2109H, A10BH/210BH) is stored. (Hexadecimal)
Cr.2	Cr.2 Argument 1 at command execution is stored.
Cr.3	Cr.3 Argument 2 at command execution is stored.

* 1 When 0FH is stored in Cr.0(15-8) Command execution result, 00H (slice position No. or start slice No. of the head module) is stored in Cr.0(7-0) Slice position No. or start slice No.

8.6 ST1AD Control Commands

8.6.1 Parameter setting read from ROM (Command No.: B100H/3100H)

Data size	
Cw	4 words (8 bytes)
Cr	4 words (8 bytes)

This command reads parameters from ROM to RAM in the ST1AD, and can be executed only in normal mode and when Bw.n+1 Convert setting request is OFF (0).

(1) Values set to "Cw" Command execution area

Table 8.58 Values set to "Cw" Command execution area

<input type="checkbox"/> Cw Command execution area	Setting value
<input type="checkbox"/> Cw.0	[For execution of command No.B100H] Set a slice position No. of the target ST1AD. (Hexadecimal)
	[For execution of command No.3100H] Set a start slice No. of the target ST1AD. (Hexadecimal)
<input type="checkbox"/> Cw.1	Set a command No. to be executed (B100H/3100H). (Hexadecimal)
<input type="checkbox"/> Cw.2	Fixed to 0000H. (Any other value is treated as 0000H.)
<input type="checkbox"/> Cw.3	

(2) Values stored in "Cr" Command result area

The command execution result data vary depending on the result data (normal completion or failure) in Cr.0(15-8) Command execution result.

(a) When completed normally ("Cr.0(15-8)" Command execution result is 00H.)

Table 8.59 Values stored in "Cr" Command result area (When completed normally)

<input type="checkbox"/> Cr Command result area	Result details
<input type="checkbox"/> Cr.0	<p>[For execution of command No.B100H] The command execution result and slice position No. in hexadecimal are stored in the high and low bytes respectively as shown below.</p> <div style="text-align: center;"> </div> <p style="text-align: center;">→ 00H: Normal completion</p>
	<p>[For execution of command No.3100H] The command execution result and start slice No. in hexadecimal are stored in the high and low bytes respectively as shown below.</p> <div style="text-align: center;"> </div> <p style="text-align: center;">→ 00H: Normal completion</p>

Table 8.59 Values stored in "Cr" Command result area (When completed normally) (Continued)

Cr Command result area	Result details
Cr.1	The executed command No. (B100H/3100H) is stored. (Hexadecimal)
Cr.2	0000H is stored.
Cr.3	

(b) When failed ("Cr.0(15-8)" Command execution result is other than 00H.)

Table 8.60 Values stored in "Cr" Command result area (When failed)

Cr Command result area	Result details
Cr.0	<p>[For execution of command No.B100H] The command execution result and slice position No. in hexadecimal are stored in the high and low bytes respectively as shown below..</p> <div style="text-align: center;"> <p style="text-align: center;"> Cr.0(15-8) Command execution result Cr.0(7-0) Slice position No. *1 </p> <p style="text-align: center;"> ↳ Other than 00H: Failure (☞ Section 8.7 Values Stored into Command Execution Result) </p> </div>
	<p>[For execution of command No.3100H] The command execution result and start slice No. in hexadecimal are stored in the high and low bytes respectively as shown below.</p> <div style="text-align: center;"> <p style="text-align: center;"> Cr.0(15-8) Command execution result Cr.0(7-0) Start slice No. *1 </p> <p style="text-align: center;"> ↳ Other than 00H: Failure (☞ Section 8.7 Values Stored into Command Execution Result) </p> </div>
Cr.1	The executed command No. (B100H/3100H) is stored. (Hexadecimal)
Cr.2	Cw.2 Argument 1 at command execution is stored.
Cr.3	Cw.3 Argument 2 at command execution is stored.

* 1 When 0FH is stored in Cr.0(15-8) Command execution result, 00H (slice position No. or start slice No. of the head module) is stored in Cr.0(7-0) Slice position No. or start slice No.

8.6.2 Parameter setting write to ROM (Command No.: B101H/3101H)

Data size	
Cw	4 words (8 bytes)
Cr	4 words (8 bytes)

This command writes parameters from RAM to ROM in the ST1AD, and can be executed only in normal mode and when Bw.n+1 Convert setting request is OFF (0).

(1) Values set to "Cw" Command execution area

Table 8.61 Values set to "Cw" Command execution area

<input type="checkbox"/> Cw Command execution area	Setting value
<input type="checkbox"/> Cw.0	[For execution of command No.B101H] Set a slice position No. of the target ST1AD. (Hexadecimal)
	[For execution of command No.3101H] Set a start slice No. of the target ST1AD. (Hexadecimal)
<input type="checkbox"/> Cw.1	Set a command No. to be executed (B101H/3101H). (Hexadecima
<input type="checkbox"/> Cw.2	Fixed to 0000H. (Any other value is treated as 0000H.)
<input type="checkbox"/> Cw.3	

(2) Values stored in "Cr" Command result area

The command execution result data vary depending on the result data (normal completion or failure) in Cr.0(15-8) Command execution result.

(a) When completed normally ("Cr.0(15-8)" Command execution result is 00H.)

Table 8.62 Values stored in "Cr" Command result area (When completed normally)

<input type="checkbox"/> Cr Command result area	Result details
<input type="checkbox"/> Cr.0	[For execution of command No.B101H] The command execution result and slice position No. in hexadecimal are stored in the high and low bytes respectively as shown below. <div style="text-align: center;"> <p style="text-align: center;">b15 ~ b8 b7 ~ b0</p> <p style="text-align: center;"> <input type="checkbox"/> Cr.0(15-8) Command execution result <input type="checkbox"/> Cr.0(7-0) Slice position No. </p> <p style="text-align: center;">→ 00H: Normal completion</p> </div>
	[For execution of command No.3101H] The command execution result and start slice No. in hexadecimal are stored in the high and low bytes respectively as shown below. <div style="text-align: center;"> <p style="text-align: center;">b15 ~ b8 b7 ~ b0</p> <p style="text-align: center;"> <input type="checkbox"/> Cr.0(15-8) Command execution result <input type="checkbox"/> Cr.0(7-0) Start slice No. </p> <p style="text-align: center;">→ 00H: Normal completion</p> </div>
<input type="checkbox"/> Cr.1	The executed command No. (B101H/3101H) is stored. (Hexadecimal)

Table 8.62 Values stored in "Cr" Command result area (When completed normally) (Continued)

Cr	Command result area	Result details
	Cr.2	0000H is stored.
	Cr.3	

(b) When failed ("Cr.0(15-8)" Command execution result is other than 00H.)

Table 8.63 Values stored in "Cr" Command result area (When failed)

Cr	Command result area	Result details
	Cr.0	<p>[For execution of command No.B101H] The command execution result and slice position No. in hexadecimal are stored in the high and low bytes respectively as shown below.</p> <p>Other than 00H: Failure (☞ Section 8.7 Values Stored into Command Execution Result)</p>
	Cr.0	<p>[For execution of command No.3101H] The command execution result and start slice No. in hexadecimal are stored in the high and low bytes respectively as shown below.</p> <p>Other than 00H: Failure (☞ Section 8.7 Values Stored into Command Execution Result)</p>
	Cr.1	The executed command No. (B101H/3101H) is stored. (Hexadecimal)
	Cr.2	Cw.2 Argument 1 at command execution is stored.
	Cr.3	Cw.3 Argument 2 at command execution is stored.

* 1 When 0FH is stored in Cr.0(15-8) Command execution result, 00H (slice position No. or start slice No. of the head module) is stored in Cr.0(7-0) Slice position No. or start slice No.

POINT

Check that the module normally operates with the set values written to RAM, before executing Parameter setting write to ROM (command No.: B101H/3101H).

8.6.3 Operation mode setting (Command No.: B102H/3102H)

Data size	
Cw	4 words (8 bytes)
Cr	4 words (8 bytes)

The mode of the ST1AD can be changed. (From normal mode to offset/gain setting mode, or from offset/gain setting mode to normal mode)

This command can be executed in normal mode and when Bw.n+1 Convert setting request is off (0), or in offset/gain setting mode.

(1) Values set to "Cw" Command execution area

Table 8.64 Values set to "Cw" Command execution area

Cw Command execution area	Setting value
Cw.0	[For execution of command No.B102H] Set a slice position No. of the target ST1AD. (Hexadecimal)
	[For execution of command No.3102H] Set a start slice No. of the target ST1AD. (Hexadecimal)
Cw.1	Set a command No. to be executed (B102H/3102H). (Hexadecimal)
Cw.2	Set an operation mode. (Hexadecimal) 0000H: Normal mode 0001H: Offset/gain setting mode
Cw.3	Fixed to 0000H. (Any other value is treated as 0000H.)

(2) Values stored in "Cr" Command result area

The command execution result data vary depending on the result data (normal completion or failure) in Cr.0(15-8) Command execution result.

(a) When completed normally ("Cr.0(15-8)" Command execution result is 00H.)

Table 8.65 Values stored in "Cr" Command result area (When completed normally)

Cr Command result area	Result details
Cr.0	[For execution of command No.B102H] The command execution result and slice position No. in hexadecimal are stored in the high and low bytes respectively as shown below. <div style="text-align: center;"> </div> <p style="text-align: center;">→ 00H: Normal completion</p>
	[For execution of command No.3102H] The command execution result and start slice No. in hexadecimal are stored in the high and low bytes respectively as shown below. <div style="text-align: center;"> </div> <p style="text-align: center;">→ 00H: Normal completion</p>

Table 8.65 Values stored in "Cr" Command result area (When completed normally) (Continued)

Cr Command result area	Result details
Cr.1	The executed command No. (B102H/3102H) is stored. (Hexadecimal)
Cr.2	Cw.2 Argument 1 at command execution is stored.
Cr.3	0000H is stored.

(b) When failed ("Cr.0(15-8)" Command execution result is other than 00H.)

Table 8.66 Values stored in "Cr" Command result area (When failed)

Cr Command result area	Result details
Cr.0	<p>[For execution of command No.B102H]</p> <p>The command execution result and slice position No. in hexadecimal are stored in the high and low bytes respectively as shown below.</p> <div style="text-align: center;"> <p style="text-align: center;"> Cr.0(15-8) Command execution result Cr.0(7-0) Slice position No. *1 </p> <p style="text-align: center;"> ↳ Other than 00H: Failure (Section 8.7 Values Stored into Command Execution Result) </p> </div>
	<p>[For execution of command No.3102H]</p> <p>The command execution result and start slice No. in hexadecimal are stored in the high and low bytes respectively as shown below.</p> <div style="text-align: center;"> <p style="text-align: center;"> Cr.0(15-8) Command execution result Cr.0(7-0) Start slice No. *1 </p> <p style="text-align: center;"> ↳ Other than 00H: Failure (Section 8.7 Values Stored into Command Execution Result) </p> </div>
Cr.1	The executed command No. (B102H/3102H) is stored. (Hexadecimal)
Cr.2	Cw.2 Argument 1 at command execution is stored.
Cr.3	Cw.3 Argument 2 at command execution is stored.

* 1 When 0FH is stored in Cr.0(15-8) Command execution result, 00H (slice position No. or start slice No. of the head module) is stored in Cr.0(7-0) Slice position No. or start slice No.

8.6.4 Offset channel specification (Command No.: B103H/3103H)

Data size	
Cw	4 words (8 bytes)
Cr	4 words (8 bytes)

This command specifies a channel and adjusts the offset value for the channel.

When this command is executed, the value of the voltage or current applied to the ST1AD is written to RAM as an offset value.

This command can be executed only in offset/gain setting mode.

(1) Values set to "Cw" Command execution area

Table 8.67 Values set to "Cw" Command execution area

Cw Command execution area	Setting value
Cw.0	[For execution of command No.B103H] Set a slice position No. of the target ST1AD. (Hexadecimal)
Cw.1	[For execution of command No.3103H] Set a start slice No. of the target ST1AD. (Hexadecimal)
Cw.2	Set a command No. to be executed (B103H/3103H). (Hexadecimal) Specify a channel for which values are adjusted by the offset value set in the offset/gain setting. Multiple channels can be set at the same time. <div style="text-align: center;"> <p>0 0 0 H</p> <p>Fixed to 0.</p> <p>b3 b2 b1 b0</p> <p>0 0</p> <p>Fixed to 0.</p> <p>CH1 Offset channel specification 0: Invalid 1: Channel to be set</p> <p>CH2 Offset channel specification 0: Invalid 1: Channel to be set</p> </div>
Cw.3	Fixed to 0000H. (Any other value is treated as 0000H.)

(2) Values stored in "Cr" Command result area

The command execution result data vary depending on the result data (normal completion or failure) in Cr.0(15-8) Command execution result.

(a) When completed normally ("Cr.0(15-8)" Command execution result is 00H.)

Table 8.68 Values stored in "Cr" Command result area (When completed normally)

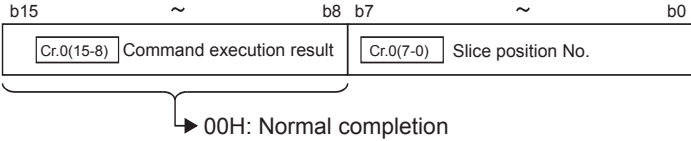
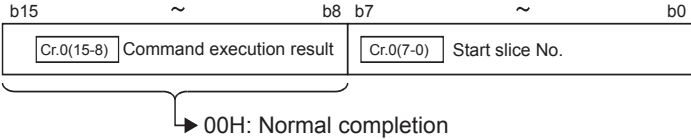
Cr Command result area	Result details
Cr.0	<p>[For execution of command No.B103H] The command execution result and slice position No. in hexadecimal are stored in the high and low bytes respectively as shown below.</p>  <p style="text-align: center;">→ 00H: Normal completion</p>
	<p>[For execution of command No.3103H] The command execution result and start slice No. in hexadecimal are stored in the high and low bytes respectively as shown below.</p>  <p style="text-align: center;">→ 00H: Normal completion</p>
Cr.1	The executed command No. (B103H/3103H) is stored. (Hexadecimal)
Cr.2	
Cr.3	0000H is stored.

(b) When failed ("Cr.0(15-8)" Command execution result is other than 00H.)

Table 8.69 Values stored in "Cr" Command result area (When failed)

Cr	Command result area	Result details
Cr.0		<p>[For execution of command No.B103H] The command execution result and slice position No. in hexadecimal are stored in the high and low bytes respectively as shown below.</p> <div style="text-align: center;"> <p style="font-size: small;">b15 ~ b8 b7 ~ b0</p> <p style="font-size: small;">Cr.0(15-8) Command execution result Cr.0(7-0) Slice position No. *1</p> </div> <p style="text-align: center;">Other than 00H: Failure (☞ Section 8.7 Values Stored into Command Execution Result)</p>
		<p>[For execution of command No.3103H] The command execution result and start slice No. in hexadecimal are stored in the high and low bytes respectively as shown below.</p> <div style="text-align: center;"> <p style="font-size: small;">b15 ~ b8 b7 ~ b0</p> <p style="font-size: small;">Cr.0(15-8) Command execution result Cr.0(7-0) Start slice No. *1</p> </div> <p style="text-align: center;">Other than 00H: Failure (☞ Section 8.7 Values Stored into Command Execution Result)</p>
	Cr.1	The executed command No. (B103H/3103H) is stored. (Hexadecimal)
	Cr.2	Cw.2 Argument 1 at command execution is stored.
	Cr.3	Cw.3 Argument 2 at command execution is stored.

* 1 When 0FH is stored in Cr.0(15-8) Command execution result, 00H (slice position No. or start slice No. of the head module) is stored in Cr.0(7-0) Slice position No. or start slice No.

8.6.5 Gain channel specification (Command No.: B104H/3104H)

Data size	
Cw	4 words (8 bytes)
Cr	4 words (8 bytes)

This command specifies a channel and adjusts the gain value for the channel.

When this command is executed, the value of the voltage or current applied to the ST1AD is written to RAM as a gain value.

This command can be executed only in offset/gain setting mode.

(1) Values set to "Cw" Command execution area

Table 8.70 Values set to "Cw" Command execution area

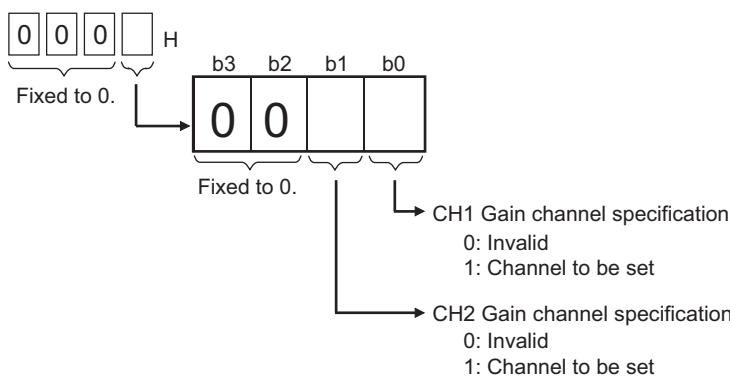
Cw Command execution area	Setting value
Cw.0	[For execution of command No.B104H] Set a slice position No. of the target ST1AD. (Hexadecimal)
Cw.1	[For execution of command No.3104H] Set a start slice No. of the target ST1AD. (Hexadecimal)
Cw.2	Set a command No. to be executed (B104H/3104H). (Hexadecimal) Specify a channel for which values are adjusted by the gain value set in the offset/gain setting. Multiple channels can be set at the same time. 
Cw.3	Fixed to 0000H. (Any other value is treated as 0000H.)

(a) When completed normally ("Cr.0(15-8)" Command execution result is 00H.)

Table 8.71 Values stored in "Cr" Command result area (When completed normally)

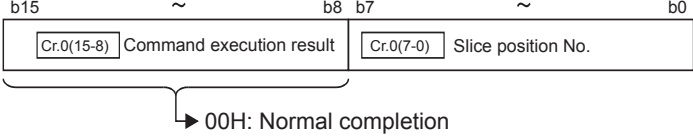
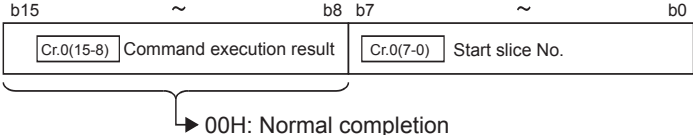
Cr Command result area	Result details
Cr.0	<p>[For execution of command No.B104H] The command execution result and slice position No. in hexadecimal are stored in the high and low bytes respectively as shown below.</p> 
	<p>[For execution of command No.3104H] The command execution result and start slice No. in hexadecimal are stored in the high and low bytes respectively as shown below.</p> 
Cr.1	The executed command No. (B104H/3104H) is stored. (Hexadecimal)
Cr.2	0000H is stored.
Cr.3	

(b) When failed ("Cr.0(15-8)" Command execution result is other than 00H.)

Table 8.72 Values stored in "Cr" Command result area (When failed)

Cr	Command result area	Result details
	Cr.0	<p>[For execution of command No.B104H] The command execution result and slice position No. in hexadecimal are stored in the high and low bytes respectively as shown below.</p> <div style="text-align: center;"> </div> <p>(☞ Section 8.7 Values Stored into Command Execution Result)</p>
		<p>[For execution of command No.3104H] The command execution result and start slice No. in hexadecimal are stored in the high and low bytes respectively as shown below.</p> <div style="text-align: center;"> </div> <p>(☞ Section 8.7 Values Stored into Command Execution Result)</p>
	Cr.1	he executed command No. (B104H/3104H) is stored. (Hexadecimal)
	Cr.2	Cw.2 Argument 1 at command execution is stored.
	Cr.3	Cw.3 Argument 2 at command execution is stored.

* 1 When 0FH is stored in Cr.0(15-8) Command execution result, 00H (slice position No. or start slice No. of the head module) is stored in Cr.0(7-0) Slice position No. or start slice No.

8.6.6 User range write (Command No.: B105H/3105H)

Data size	
Cw	4 words (8 bytes)
Cr	4 words (8 bytes)

This command writes adjusted offset/gain setting values to ROM of the ST1AD, and can be executed only in offset/gain setting mode.

(1) Values set to "Cw" Command execution area

Table 8.73 Values set to "Cw" Command execution area

Cw Command execution area	Setting value
Cw.0	[For execution of command No.B105H] Set a slice position No. of the target ST1AD. (Hexadecimal)
Cw.1	[For execution of command No.3105H] Set a start slice No. of the target ST1AD. (Hexadecimal)
Cw.2	Set a command No. to be executed (B105H/3105H). (Hexadecimal)
Cw.3	Fixed to 0000H. (Any other value is treated as 0000H.)

(2) Values stored in "Cr" Command result area

The command execution result data vary depending on the result data (normal completion or failure) in Cr.0(15-8) Command execution result.

(a) When completed normally ("Cr.0(15-8)" Command execution result is 00H.)

Table 8.74 Values stored in "Cr" Command result area (When completed normally)

Cr Command result area	Result details
Cr.0	<p>[For execution of command No.B105H] The command execution result and slice position No. in hexadecimal are stored in the high and low bytes respectively as shown below.</p> <div style="text-align: center;"> </div>
Cr.0	<p>[For execution of command No.3105H] The command execution result and start slice No. in hexadecimal are stored in the high and low bytes respectively as shown below.</p> <div style="text-align: center;"> </div>
Cr.1	The executed command No. (B105H/3105H) is stored. (Hexadecimal)

Table 8.74 Values stored in "Cr" Command result area (When completed normally) (Continued)

Cr Command result area	Result details
Cr.2	0000H is stored.
Cr.3	

(b) When failed ("Cr.0(15-8)" Command execution result is other than 00H.)

Table 8.75 Values stored in "Cr" Command result area (When failed)

Cr Command result area	Result details
Cr.0	<p>[For execution of command No.B105H] The command execution result and slice position No. in hexadecimal are stored in the high and low bytes respectively as shown below.</p> <div style="text-align: center;"> <p style="text-align: center;"> Cr.0(15-8) Command execution result Cr.0(7-0) Slice position No. *1 </p> </div> <p style="text-align: center;"> ↳ Other than 00H: Failure (☞ Section 8.7 Values Stored into Command Execution Result) </p>
Cr.0	<p>[For execution of command No.3105H] The command execution result and start slice No. in hexadecimal are stored in the high and low bytes respectively as shown below.</p> <div style="text-align: center;"> <p style="text-align: center;"> Cr.0(15-8) Command execution result Cr.0(7-0) Start slice No. *1 </p> </div> <p style="text-align: center;"> ↳ Other than 00H: Failure (☞ Section 8.7 Values Stored into Command Execution Result) </p>
Cr.1	The executed command No. (B105H/3105H) is stored. (Hexadecimal)
Cr.2	Cw.2 Argument 1 at command execution is stored.
Cr.3	Cw.3 Argument 2 at command execution is stored.

* 1 When 0FH is stored in Cr.0(15-8) Command execution result, 00H (slice position No. or start slice No. of the head module) is stored in Cr.0(7-0) Slice position No. or start slice No.

8.7 Values Stored into Command Execution Result

The following table indicates the values stored into $\boxed{\text{Cr.n(15-8)}}$ Command execution result in $\boxed{\text{Cr}}$ Command result area.

Table 8.76 Command execution results and actions

Command execution result	Description	Action
00H	Normal completion	-
01H	The requested command is not available for the specified module.	Check Table 8.1 to see if the requested command No. is applicable for the ST1AD or not. Check if the specified $\boxed{\text{Cw.0}}$ Slice position No. or start slice No. matches $\boxed{\text{Cw.0}}$ Slice position No. or start slice No. of the ST1AD.
02H	The value is out of range.	Check if the values set in $\boxed{\text{Cw.2}}$ and subsequent area in the command execution area are within the range available for the requested command No.
03H	The specified target start slice position No. or start slice No. is incorrect.	Check if the ST1AD is mounted in the position of the specified $\boxed{\text{Cw.0}}$ slice position No. or start slice No. Check if the specified $\boxed{\text{Cw.0}}$ slice position No. or start slice No. matches start slice No. of the ST1AD.
04H	There is no response from the specified module.	Check Table 8.1 to see if the requested command No. can be used for the ST1AD or not. If the requested command No. is applicable, the ST1AD may be faulty. Please consult your local Mitsubishi representative, explaining a detailed description of the problem.
05H	No communication is available with the specified module.	The ST1AD may be faulty. Please consult your local Mitsubishi representative, explaining a detailed description of the problem.
06H	The requested command is not executable in the current operation mode of the module.	Check Table 8.1 to see if the requested command No. can be used in the operation mode or not. The number of user range writes (command No.: B105H/3105H) or parameter writes to ROM (command No.: B101H/3101H) exceeded 25 after power ON (error code: 1200H). Clear the error ^{*1} , and then execute the command. The offset value is equal to or greater than the gain value in the offset/gain setting (error code: 400□H). Clear the error ^{*1} , and then redo the offset/gain setting so that the offset value is less than the gain value.
07H	The module has already been in the specified mode.	Continue the processing since the operation mode of the ST1AD specified by $\boxed{\text{Cw.0}}$ slice position No. or start slice No. is already the requested mode.
08H	The mode of the module cannot be changed to the specified mode.	Set $\boxed{\text{Bw.n+1}}$ Convert setting request to OFF (0), and then execute the command.

Table 8.76 Command execution results and actions (Continued)

Command execution result	Description	Action
09H	The specified module is in the online module change status.	Execute the command after completion of the online module change.
0AH	The specified module No. is different, or does not exist.	Check if the command parameter setting of the intelligent function module is appropriate to the specified module No.
0FH	The value of <input type="text" value="Cw.0"/> slice position No. or start slice No. is out of range.	Check if the value set for <input type="text" value="Cw.0"/> slice position No. or start slice No. is within the range or not.
10H	Data cannot be read from the specified module.	Execute the command again. If the problem on the left occurs again, the ST1AD may be faulty.
11H	Data cannot be written to the specified module.	Please consult your local Mitsubishi representative, explaining a detailed description of the problem.
13H	The specified module is not in the status available for command parameter writing.	Set <input type="text" value="Bw.n+1"/> Convert setting request to OFF (0), and then execute the command.

* 1 Clear the error by either of the following methods.

- Error clear request (command No.: 8104H/0104H)
- Error reset request (RYnA)

For details of the above, refer to the following.

 MELSEC-ST CC-Link Head Module User's Manual, "8.2.5 Error clear request (Command No.: 8104H/0104H)"

 MELSEC-ST CC-Link Head Module User's Manual, "3.4 Remote I/O, Remote Registers"

CHAPTER9 TROUBLESHOOTING

This chapter explains the errors that may occur when the ST1AD is used, and how to troubleshoot them.

9.1 Error Code List

In the ST1AD, when an error occurs due to data writing to the master module, executing Error code read request (command No.: 8101H/0101H) stores an error code into Cr Command result area of the head module.

Table 9.1 Error code list (1/2)

Error code (Hexadecimal)	Error level	Error name	Description	Corrective action
1100H	System error	ROM error	ROM fault.	Power the ST1AD off and then on, or reset the head module. If the error code given on the left is still stored, the possible cause is a ST1AD failure. Please consult your local Mitsubishi representative, explaining a detailed description of the problem.
1200H	System error	ROM write count error	Parameter setting write to ROM (command No.: B101H/3101H) or User range write (command No.: B105H/3105H) was executed more than 25 times after power-on.	After power-on, execute the command for a single module, or write offset/gain settings to the ROM using GX Configurator-ST, within 25 times.
			Offset/gain settings were written to the ROM using GX Configurator-ST more than 25 times after power-on.	
1300H	System error	Converter error	A converter error has occurred.	Turn the convert setting request off to clear the error. Then, turn the convert setting request on again.
200□H	System error	Input range setting error	The value set to input range setting is outside the valid range. □ indicates the channel number causing the error.	Set a value that is within the valid range.
210□H	System error	Average setting error	The average time setting is outside the range 2 to 5000ms. □ indicates the channel number causing the error.	Set a value that is within the valid range.
220□H	System error	Average setting error	The average number of times setting is outside the range 4 to 62500 times. □ indicates the channel number causing the error.	Set a value that is within the valid range.

Table 9.2 Error code list (2/2)

Error code (Hexadecimal)	Error level	Error name	Description	Corrective action
300□H	System error	Alarm setting error	The value set to the upper upper limit value/upper lower limit value/lower upper limit value/lower lower limit value of the alarm output is outside the valid range. The setting range is indicated below. ST1AD2-V: -4096 to 4095 ST1AD2-I: -96 to 4095 □ indicates the channel number causing the error.	Set a value that is within the valid range.
312 □H	System error	Alarm setting error	In the lower upper limit value/lower lower limit value of the alarm output, the lower upper limit value is less than the lower lower limit value. □ indicates the channel number causing the error.	Re-set the limit values so that the condition of upper upper limit value \geq upper lower limit value \geq lower upper limit value \geq lower lower limit value is satisfied.
313□H	System error	Alarm setting error	In the upper lower limit value/lower upper limit value of the alarm output, the upper lower limit value is less than the lower upper limit value. □ indicates the channel number causing the error.	
314□H	System error	Alarm setting error	In the upper upper limit value/upper lower limit value of the alarm output, the upper upper limit value is less than the upper lower limit value. value. □ indicates the channel number causing the error.	
400□H	System error	User range setting error	In User range setting, offset value is equal to or greater than gain value. □ indicates the channel number causing the error.	Reset the range so that offset value is smaller than gain value.
500□H	System error	Disconnection detection error	Line break down has been detected. □ indicates the channel number causing the error.	Check for any abnormality on the signal lines by doing a visual check and performing a continuity check.
B10□H to FFFF	-	(Error detected by head module)	-	Referring to the following, take actions.  MELSEC-ST CC-Link Head Module User's Manual, "9.7.2 Error code list"

☒ POINT

- (1) When multiple errors of the same level occur, the code of the error first found by the ST1AD is stored.
- (2) The error can be cleared by either of the following methods:
 - Error clear request (command No.: 8104H/0104H)
 - Error reset request (RYnA)

For details of the above methods, refer to the following.

☞ MELSEC-ST CC-Link Head Module User's Manual, "8.2.5 Error clear request (Command No.: 8104H/0104H)

☞ MELSEC-ST CC-Link Head Module User's Manual, "3.4 Remote I/O, Remote Registers"

9.2 Troubleshooting

9.2.1 When the RUN LED is flashing or turned off

(1) When flashing at 0.5s intervals

Table 9.3 When flashing at 0.5s intervals

Check item	Corrective action
Is the mode set to the offset/gain setting mode?	Execute Operation mode setting (command No.: B102H/3202H) to select the normal mode.  Section 8.6.3 Operation mode setting (Command No.: B102H/3102H)

(2) When flashing at 0.25s intervals

Table 9.4 When flashing at 0.25s intervals

Check item	Corrective action
Is the module selected as the target of online module change?	Refer to the following and take corrective action.  CHAPTER 7 ONLINE MODULE CHANGE

(3) When flashing at 1s intervals

Table 9.5 When flashing at 1s intervals

Check item	Corrective action
Has cyclic transmission been stopped between the master station and head module?	Refer to the following and take corrective action.  MELSEC-ST System User's Manual
Has a parameter communication error occurred between the master station and head module?	
Has an error occurred in another slice module?	
Has an internal bus error occurred?	

(4) When turned off

Table 9.6 When turned off

Check item	Corrective action
Is a module change enabled during an online module change?	Refer to the following and take corrective action.  CHAPTER 7 ONLINE MODULE CHANGE
Is External SYS. power supply being supplied?	Check whether the supply voltage of the bus refreshing module is within the rated range.
Is the capacity of the bus refreshing module adequate?	Calculate the current consumption of the mounted module, and check that the power supply capacity is sufficient.
Is the ST1AD correctly mounted on the base module?	Check the mounting condition of the ST1AD.
Has a watchdog timer error occurred?	Power the ST1AD off and then on, or reset the head module, and check whether the LED turns on. If the LED still does not turn on, the possible cause is a ST1AD failure. Please consult your local Mitsubishi representative, explaining a detailed description of the problem.









9.2.2 When the RUN and ERR. LEDs turned on

Table 9.7 When the RUN and ERR. LEDs turned on

Check item	Corrective action
Has an error occurred	Confirm the error code and take corrective action described in the error code list.  Section 9.1 Error Code List

9.2.3 When digital output values cannot be read

Table 9.8 When digital output values cannot be read

Check item	Corrective action
Is external AUX. power supply being supplied?	Check whether the power distribution modules is supplied with a 24V DC voltage.
Is there any fault with the analog signal lines such as broken or disconnected line?	Check for any abnormality on the signal lines by doing a visual check and performing a continuity check.
Are the offset/gain settings correct?	<p>Check if the offset/gain settings are correct.</p> <ul style="list-style-type: none"> •Checking by GX Configurator-ST <ul style="list-style-type: none">  Section 5.6 Offset/Gain Setting •Checking by commands <ul style="list-style-type: none">  Section 4.5 Offset/Gain Settings <p>When the user range setting is used, switch it to the factory-set output range and check whether A/D conversion is performed correctly or not.</p> <p>If it is correctly performed, redo the offset/gain setting.</p>
Is the input range setting correct?	<p>Execute Input range set value read (command No.: 9118H/1118H) and confirm the input range setting.</p> <p> Section 8.4.8 Input range setting read (Command No.: 9118H/1118H)</p> <p>If the input range setting is wrong, reset the input range setting in GX Configurator-ST, or modify the program for setting command parameters.</p>
Is the A/D conversion enable/disable setting for the channel, where data was input, set to Disable?	<p>Execute A/D conversion enable/disable setting read (command No.: 9100H/1100H) and confirm the A/D conversion enable/disable setting.</p> <p> Section 8.4.1 A/D conversion enable/disable setting read (Command No.: 9100H/1100H)</p> <p>If conversion is disabled, enable conversion by GX Configurator-ST or by executing A/D conversion enable/disable setting write (command no.: A100H/2100H).</p> <p> Section 5.3 Parameter Setting</p> <p> Section 8.5.1 A/D conversion enable/disable setting write (Command No.: A100H/2100H)</p>
Are <input type="checkbox"/> Bw.n+1 convert setting request and <input type="checkbox"/> Br.n+1 convert setting completed flag on?	<p>Check whether <input type="checkbox"/> Bw.n+1 convert setting request and <input type="checkbox"/> Br.n+1 convert setting completed flag are on or off using the program of the master station or the I/O monitor of GX Configurator-ST.</p> <p> Section 5.4 Input/Output Monitor</p> <p>If <input type="checkbox"/> Bw.n+1 convert setting request and <input type="checkbox"/> Br.n+1 convert setting completed flag are off, reexamine the program of the master station.</p> <p> Section 3.4.1 Bit input area</p> <p> Section 3.4.2 Word input area</p>

☒ POINT

The module may be faulty if digital output values cannot be read after proper corrective action have been taken according to the above. Please consult your local Mitsubishi representative, explaining a detailed description of the problem.

APPENDIX

Appendix 1 Accessories

This section explains the accessories related to the ST1AD.

(1) Wiring maker

For how to use the wiring marker, refer to the following.

 MELSEC-ST System User's Manual, "10.2 Mounting the Modules"

Table App.1 Wiring marker list



Model name	Description	Color
ST1A-WMK-BL	Terminal marker (-, 0V, N)	Blue
ST1A-WMK-GN	Terminal marker (Shield)	Green
ST1A-WMK-BK	Terminal marker (Signal wire)	Black

(2) Coding element

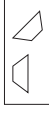

The coding element is fitted before shipment.

It is also available as an option in case it is lost.

Table App.2

Model name	Description	Shape *1		Color
		Base module side	Slice module side	
ST1A-CKY-13	Coding element for ST1AD2-V			Green
ST1A-CKY-14	Coding element for ST1AD2-I			

* 1 Indicates the position of the projection or hole when the coding element is viewed from above.

 : Protection  : Hole

Appendix 2 External Dimensions

(1) ST1AD2-V

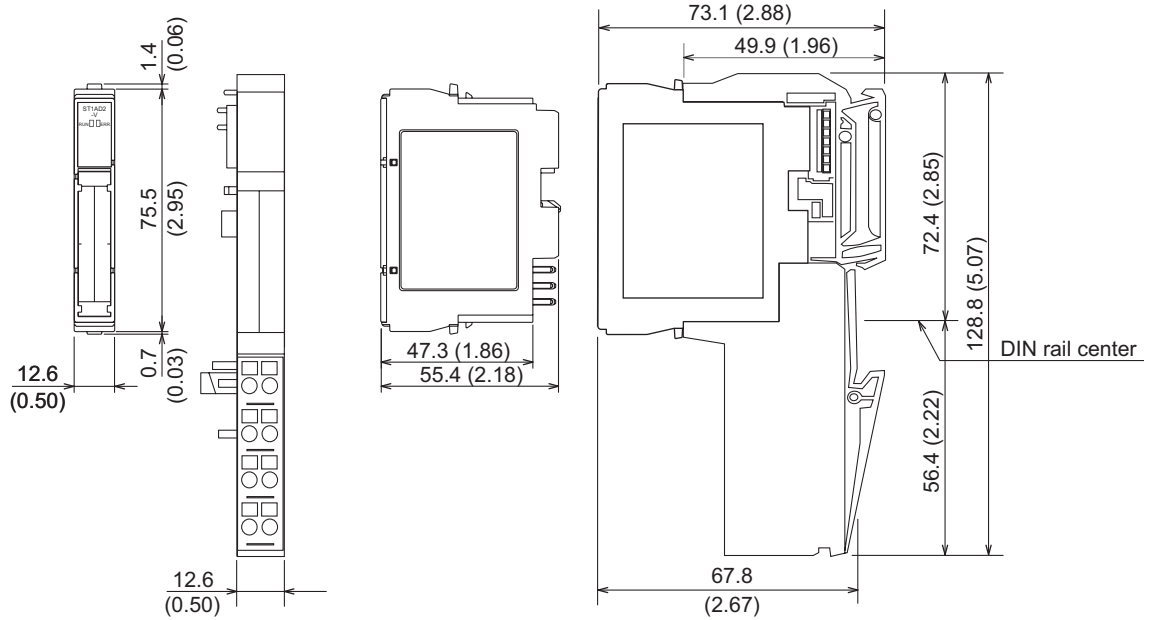

Unit: mm (inch)

(2) ST1AD2-I

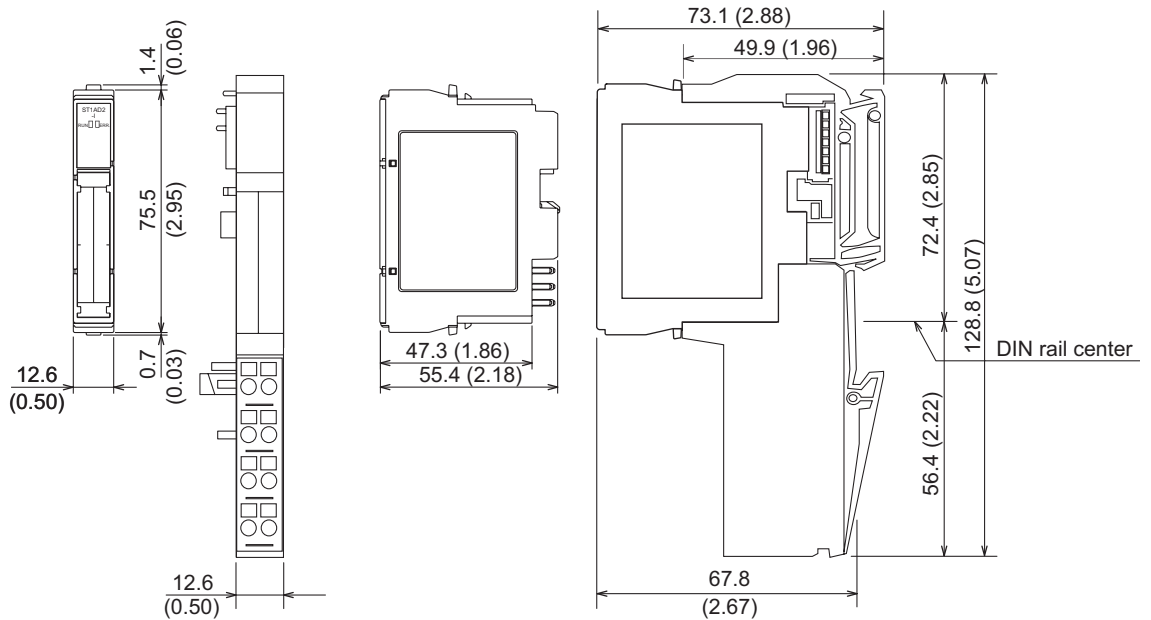

Unit: mm (inch)

Remark

For ST1AD2-V, ST1AD2-I of hardware version C or before, side face diagram of the module is as follows.

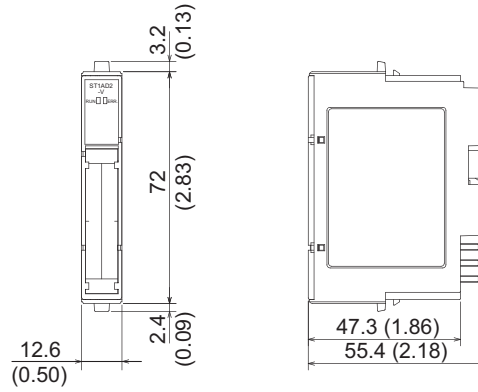

Unit: mm (inch)

INDEX

[A]

- Absolute maximum input 3-1
- Accessories App-1
- Accuracy 3-1, 3-6
- Alarm output function 3-9, 3-12
- Alarm output signal 3-18
- Analog input range 3-1
- Applicable base module 2-2
- Applicable coding element 2-2
- Applicable head module 2-2
- Applicable software package 2-2
- Applicable System 2-2
- Averaging process 3-10
- A/D conversion channel read 8-17
- A/D conversion completed flag 3-18
- A/D conversion enable/disable function 3-8
- A/D conversion enable/disable setting read 8-15
- A/D conversion enable/disable setting write 8-33
- A/D conversion method 3-8, 3-10

[B]

- Bit input area 3-17
- Bit output area 3-19
- Br 3-17
- Bw 3-19

[C]

- Coding element 4-3, App-1
- Command execution area 8-5
- Command parameter 3-21
- Command result area 8-5
- COMMANDS 8-1
- Conversion speed 3-1
- Convert setting completed flag 3-17
- Convert setting request 3-19
- Cr 8-5
- Creating a project 5-2
- Cw 8-5

[D]

- Data symbol A-11
- Digital output 3-1
- Disconnection detection function 3-9, 3-14

[E]

- EMC A-10
- Error clear request 3-14
- Error Code List 9-1
- Error code read request 8-7
- Error reset request 3-14
- External Dimensions App-2
- External wiring 4-6

[F]

- Features 1-1
- Forced Output Test 5-8

[G]

- Gain channel specification 8-60
- GX Configurator-ST Functions 5-1

[H]

- Handling Precautions 4-1

[I]

- Initial data batch write request 8-9
- Initial data individual write request 8-12
- Input range 1-1
- Input range changing function 3-8
- Input range setting read 8-30
- Input/Output Monitor 5-6
- Intelligent function module processing time 3-7
- internal current consumption 3-1
- Isolation specifications 3-1
- I/O characteristics 3-1
- I/O Conversion Characteristics 3-2
- I/O Data 3-16

[L]

- LED 4-4
- Low Voltage Directives A-10
- lower upper limit/lower lower limit setting read 8-28
- lower upper limit/lower lower limit setting write 8-48

[M]

- Maximum resolution 3-1
- maximum resolution 3-5
- Memory 3-20
- Message transmission A-12
- Module ready 3-17

[N]

- Notch filter processing 3-9
- notch filter processing 3-7
- Notch filter setting read 8-22
- Notch filter setting write 8-39
- Number of occupied I/O points 3-1

[O]

- Offset channel specification 8-57
- Offset/Gain Setting 5-10
- Offset/Gain Settings 4-9
- ONLINE MODULE CHANGE 7-1
- Operating condition setting write 8-36
- Operating status read request 8-5
- Operation condition setting read 8-19

Operation mode setting8-55

[P]

Parameter Setting 5-3
Parameter setting read from ROM8-51
Parameter setting write to ROM8-53
Parameters3-21
Performance Specifications 3-1
Precautions for Online Module Change 7-1
Precautions for System Configuration 2-3
Program example.....4-13
Program Examples 6-9
PROGRAMMING 6-1

[R]

RAM3-20
Remote input A-12
Remote output A-12
Remote register A-12
Resolution 3-5
ROM3-20

[S]

Sampling process3-10
Setting command parameters.....3-21
Settings and Communication Data 6-5

[T]

Terminal block..... 4-3
time/count averaging setting read8-24
time/count averaging setting write.....8-42
TROUBLESHOOTING 9-1
Troubleshooting..... 9-4

[U]

upper upper limit/upper lower limit setting read...8-26
upper upper limit/upper lower limit setting write ..8-45
User range write8-63

[V]

Values Stored into Command Execution Result...8-65

[W]

Wiring maker App-1
Wiring precautions 4-5
Word input area3-19
Wr3-19
Ww3-16

Warranty

Please confirm the following product warranty details before using this product.

1. Gratis Warranty Term and Gratis Warranty Range

If any faults or defects (hereinafter "Failure") found to be the responsibility of Mitsubishi occurs during use of the product within the gratis warranty term, the product shall be repaired at no cost via the sales representative or Mitsubishi Service Company.

However, if repairs are required onsite at domestic or overseas location, expenses to send an engineer will be solely at the customer's discretion. Mitsubishi shall not be held responsible for any re-commissioning, maintenance, or testing on-site that involves replacement of the failed module.

[Gratis Warranty Term]

The gratis warranty term of the product shall be for one year after the date of purchase or delivery to a designated place.

Note that after manufacture and shipment from Mitsubishi, the maximum distribution period shall be six (6) months, and the longest gratis warranty term after manufacturing shall be eighteen (18) months. The gratis warranty term of repair parts shall not exceed the gratis warranty term before repairs.

[Gratis Warranty Range]

- (1) The range shall be limited to normal use within the usage state, usage methods and usage environment, etc., which follow the conditions and precautions, etc., given in the instruction manual, user's manual and caution labels on the product.
- (2) Even within the gratis warranty term, repairs shall be charged for in the following cases.
 1. Failure occurring from inappropriate storage or handling, carelessness or negligence by the user. Failure caused by the user's hardware or software design.
 2. Failure caused by unapproved modifications, etc., to the product by the user.
 3. When the Mitsubishi product is assembled into a user's device, Failure that could have been avoided if functions or structures, judged as necessary in the legal safety measures the user's device is subject to or as necessary by industry standards, had been provided.
 4. Failure that could have been avoided if consumable parts (battery, backlight, fuse, etc.) designated in the instruction manual had been correctly serviced or replaced.
 5. Failure caused by external irresistible forces such as fires or abnormal voltages, and Failure caused by force majeure such as earthquakes, lightning, wind and water damage.
 6. Failure caused by reasons unpredictable by scientific technology standards at time of shipment from Mitsubishi.
 7. Any other failure found not to be the responsibility of Mitsubishi or that admitted not to be so by the user.

2. Onerous repair term after discontinuation of production

- (1) Mitsubishi shall accept onerous product repairs for seven (7) years after production of the product is discontinued.

Discontinuation of production shall be notified with Mitsubishi Technical Bulletins, etc.

- (2) Product supply (including repair parts) is not available after production is discontinued.

3. Overseas service

Overseas, repairs shall be accepted by Mitsubishi's local overseas FA Center. Note that the repair conditions at each FA Center may differ.

4. Exclusion of loss in opportunity and secondary loss from warranty liability

Regardless of the gratis warranty term, Mitsubishi shall not be liable for compensation of damages caused by any cause found not to be the responsibility of Mitsubishi, loss in opportunity, lost profits incurred to the user by Failures of Mitsubishi products, special damages and secondary damages whether foreseeable or not, compensation for accidents, and compensation for damages to products other than Mitsubishi products, replacement by the user, maintenance of on-site equipment, start-up test run and other tasks.

5. Changes in product specifications

The specifications given in the catalogs, manuals or technical documents are subject to change without prior notice.

6. Product application

- (1) In using the Mitsubishi MELSEC programmable controller, the usage conditions shall be that the application will not lead to a major accident even if any problem or fault should occur in the programmable controller device, and that backup and fail-safe functions are systematically provided outside of the device for any problem or fault.

- (2) The Mitsubishi programmable controller has been designed and manufactured for applications in general industries, etc. Thus, applications in which the public could be affected such as in nuclear power plants and other power plants operated by respective power companies, and applications in which a special quality assurance system is required, such as for Railway companies or Public service purposes shall be excluded from the programmable controller applications.

In addition, applications in which human life or property that could be greatly affected, such as in aircraft, medical applications, incineration and fuel devices, manned transportation, equipment for recreation and amusement, and safety devices, shall also be excluded from the programmable controller range of applications.

However, in certain cases, some applications may be possible, providing the user consults their local Mitsubishi representative outlining the special requirements of the project, and providing that all parties concerned agree to the special circumstances, solely at the users discretion.

Company names and product names used in this document are trademarks or registered trademarks of respective companies.

MELSEC-ST Analog-Digital Converter Module

User's Manual (CC-Link)

MODEL	ST1AD-BT-U-SY-E
MODEL CODE	13JZ12
SH(NA)-080755ENG-A(0805)MEE	



HEAD OFFICE : TOKYO BUILDING, 2-7-3 MARUNOUCHI, CHIYODA-KU, TOKYO 100-8310, JAPAN
NAGOYA WORKS : 1-14, YADA-MINAMI 5-CHOME, HIGASHI-KU, NAGOYA, JAPAN

When exported from Japan, this manual does not require application to the
Ministry of Economy, Trade and Industry for service transaction permission.

Specifications subject to change without notice.